

BIC®
WRITING
INSTRUMENTS

01

Discover the new generation of the BIC® Cristal® pens.

The **BIC® Cristal® Expression** blends timeless design with vibrant BritePix™ personalisation. The **BIC® Cristal® Re'New™** features a durable matte silver metal barrel with a 96% recycled plastic cap, while the **BIC® Cristal® Re'New™ Black** adds a glossy, sophisticated finish to the iconic **BIC® Cristal® Re'New™**.

FR/

Découvrez la nouvelle génération de stylos BIC® Cristal®.

Le BIC® Cristal® Expression allie un design intemporel à une personnalisation BritePix™ éclatante. Le **BIC® Cristal® Re'New™** se caractérise par un corps métallique argenté mat durable et un capuchon en plastique recyclé à 96 %, tandis que le **BIC® Cristal® Re'New™ Black** ajoute une finition brillante et sophistiquée à l'emblématique **BIC® Cristal® Re'New™**.

DE/

Entdecken Sie die neue Generation der BIC® Cristal®-Stifte.

Der BIC® Cristal® Expression verbindet zeitloses Design mit lebendiger BritePix™-Personalisierung. Der **BIC® Cristal® Re'New™** verfügt über einen robusten, matt silbernen Metallschaft mit einer Kappe aus 96 % recyceltem Kunststoff, während der **BIC® Cristal® Re'New™ Black** dem ikonischen **BIC® Cristal® Re'New™** ein glänzendes, elegantes Finish verleiht.

IT/

Scopri la nuova generazione di penne BIC® Cristal®.

La BIC® Cristal® Expression unisce un design intramontabile alla vivace personalizzazione BritePix™. La **BIC® Cristal® Re'New™** presenta un resistente fusto in metallo argento opaco con un cappuccio in plastica riciclata al 96%, mentre la **BIC® Cristal® Re'New™ Black** aggiunge una finitura lucida e sofisticata all'iconica **BIC® Cristal® Re'New™**.

ES/

Descubre la nueva generación de bolígrafos BIC® Cristal®.

El BIC® Cristal® Expression combina un diseño atemporal con la vibrante personalización BritePix™. El **BIC® Cristal® Re'New™** cuenta con un cuerpo metálico plateado mate resistente y un capuchón de plástico reciclado en un 96 %, mientras que el **BIC® Cristal® Re'New™ Black** añade un acabado brillante y sofisticado al icónico **BIC® Cristal® Re'New™**.

Writes Up to 3km



1095
BIC® Cristal®
Expression



1095
BIC® Cristal®
Expression

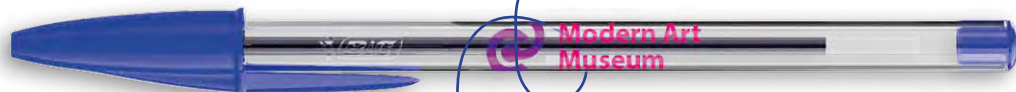

1095
BIC® Cristal®
Expression

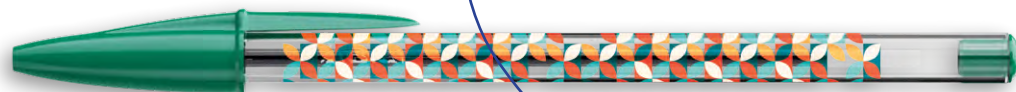

1095
BIC® Cristal®
Expression



1090
BIC® Cristal®
Re'New™



1092
BIC® Cristal®
Re'New™ Black



Iconic object of design.

1095

BIC® CRISTAL®
EXPRESSION

1095

Ink Colour



02



03



05



04

1:1 scale

FR
**Objet emblématique
du design.**

DE
**Legendäres
Designobjekt.**

IT
**Oggetto iconico
di design.**

ES
**Objeto icónico
de diseño.**

1095

BIC® CRISTAL® EXPRESSION

1095

A BP: BritePix™ Digital

MOQ 250 units

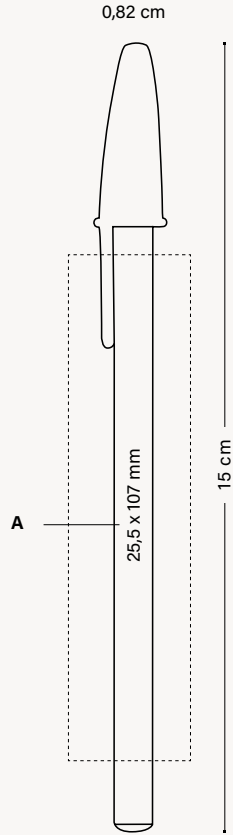

OPTIONAL SPECIAL PACKAGING



BIC® COLLECTION BOX
SLIM PENS 4 UNITS

+ INFO PAGES 254 TO 265

EXTERNAL PACKAGING



500 ± 3,5 KG



WRITING
MODES



PRINTING
TECHNIQUES



BRITEPIX™ DIGITAL

SUSTAINABILITY



CHECK OUT THE VIDEO

BIC
GRAPHIC

BIC®
WRITING INSTRUMENTS

OTHER WRITING
INSTRUMENTS

NOTEBOOKS

BIC® / BIC® LIGHTERS
AND BIC® CASES

BIC®
PACKAGING

GENERAL
INFORMATION

See pages 272-276 for a detailed explanation of the icons.

Elegance dressed in metal.

1090

BIC® CRISTAL®
RE'NEW™

1090

Ink Colour



18

18

18

1:1 scale

BIC® WINDOW BOX

1 pen + 2 refills



*Your BIC® Cristal® Re'New™
comes with this packaging!*

(Included in the price)

FR

**L'élégance vêtue
de métal.**

DE

**Eleganz in Metall
gekleidet.**

IT

**Eleganza vestita
di metallo.**

ES

**Elegancia
vestida de metal.**

1090

BIC® CRISTAL® RE'NEW™

1090

A LE: max. 1 col.

MOQ 25 units

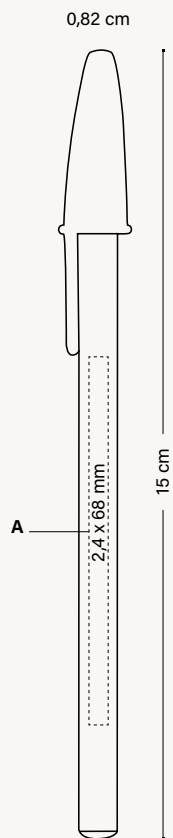

EXTERNAL PACKAGING



44 ± 1KG



WRITING MODES



PRINTING TECHNIQUES



SUSTAINABILITY



BIC GRAPHIC

BIC® WRITING INSTRUMENTS

OTHER WRITING INSTRUMENTS

NOTEBOOKS

BIC® / D'JEEP® LIGHTERS AND BIC® CASES

BIC® PACKAGING

GENERAL INFORMATION

See pages 272-276 for a detailed explanation of the icons.

Sleek. Elegant. Refillable.

1092

**BIC® CRISTAL®
RE'NEW™ BLACK**
1092

Ink Colour



NEW!



18



18

BIC® WINDOW BOX

1 pen with black ink + 1 blue refill



*Your BIC® Cristal® Re'New™ Black
comes with this packaging!*

(Included in the price)

FR/
**Élégant. Raffiné.
Rechargeable.**

DE/
**Schlank. Elegant.
Nachfüllbar.**

IT/
**Elegante. Raffinato.
Ricaricabile.**

ES/
**Elegante. Sofisticado.
Recargable.**

BIC® CRISTAL® RE'NEW™ BLACK

1092

BIC® CRISTAL® RE'NEW™ BLACK
1092

A LE: max. 1 col.

MOQ 25 units

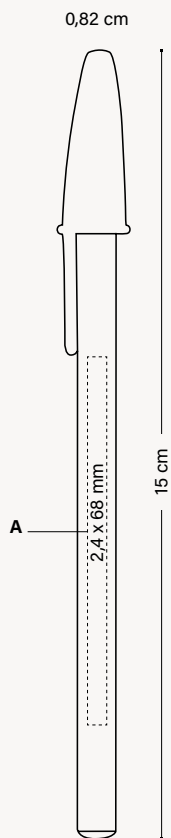

EXTERNAL PACKAGING



WRITING
MODES



PRINTING
TECHNIQUES



SUSTAINABILITY



BIC
GRAPHIC

BIC®
WRITING INSTRUMENTS

OTHER WRITING
INSTRUMENTS

NOTEBOOKS

BIC® / D'JEEP® LIGHTERS
AND BIC® CASES

BIC®
PACKAGING

GENERAL
INFORMATION

See pages 272-276 for a detailed explanation of the icons.

BIC® STYLE

Globally renowned BIC® cap design.

The BIC® Style offers excellent
value for money.

FR/

**Facilement reconnaissable
dans le monde entier grâce à
son capuchon emblématique.**

Le BIC® Style offre un excellent rapport
qualité-prix.

DE/

**Weltweit leicht an der
legendären Kappe zu erkennen.**

Der BIC® Style bietet ein
hervorragendes Preis-Leistungs-
Verhältnis.

IT/

**Riconoscibile facilmente
grazie al suo tappo iconico.**

BIC® Style offre un eccellente
rapporto qualità-prezzo.

ES/

**Reconocido mundialmente
por su icónico capuchón.**

El BIC® Style ofrece una excelente
relación calidad precio.

Simple and recognizable.

A classic Style



1610

BIC® STYLE
1610 Opaque

Ink Colour



01/01

01/03

01/04

01/02

02/02

04

10

●
Only available
in black ink

●
Only available
in blue ink

●
Only available
in black ink

1:1 scale



**WRITING
MODES**



**PRINTING
TECHNIQUES**



SUSTAINABILITY



See pages 272-276 for a detailed explanation of the icons.

1610

BIC® STYLE
1610 Clear

Ink Colour



92

87

88

89

8H

93

1:1 scale

1610

BIC® STYLE

1610 Opaque
A SP: max. 1 col.

BIC® STYLE

1610 Clear
B SP: max. 1 col.

MOQ 500 units

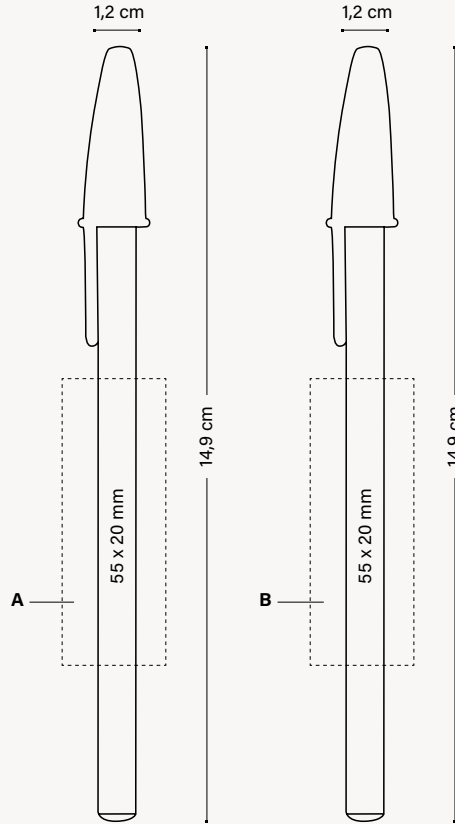

WRITING MODES



PRINTING TECHNIQUES



SUSTAINABILITY



OPTIONAL SPECIAL PACKAGING



PLASTIC POUCH

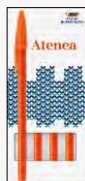

BIC® COLLECTION BOX
SLIM PENS 4 UNITS

+ INFO PAGES 254 TO 265

EXTERNAL PACKAGING



500 ± 3,5 KG

Can be used
as bookmark

BIC® ROUND STIC®

The BIC® Round Stic® offers a timeless design, smooth writing and high quality.

FR/

Le BIC® Round Stic® offre un design intemporel, une écriture fluide et une grande qualité.

DE/

Der BIC® Round Stic® bietet ein zeitloses Design, ein angenehmes Schreibgefühl und hohe Qualität.

IT/

La BIC® Round Stic® offre un design senza tempo, una scrittura scorrevole e un'elevata qualità.

ES/

El BIC® Round Stic® ofrece un diseño atemporal, una escritura suave y alta calidad.



Writing made
a pleasure

1010

BIC® ROUND STIC®
1010 Opaque

Ink Colour
● ● ●

Red Ink available under request



*Embossed
iconic BIC® brand!*



*Only available
on white barrel*



PERSONALISED
COLOURS



MANUFACTURED
AND PRINTED IN
BIC FACTORIES



MADE
IN SPAIN



REGULATORY
COMPLIANCE



WRITING
MODES



BALLPEN M
Ø 1 MM

PRINTING
TECHNIQUES



SCREEN PRINTING



DIGITAL

SUSTAINABILITY



100% ELECTRICITY
COMING FROM
RENEWABLE SOURCES

1010

BIC® ROUND STIC®
1010 Frosted

Ink Colour
● ● ●

Red Ink available under request



69

63

71

66

68

67

40

1:1 scale

**Available in selected countries, please ask your customer service representative.*

BIC® ROUND STIC®

ECO version and standard at the same price!



1E10

BIC® ROUND STIC®
1E10 Opaque

Ink Colour
● ● ●

Red Ink available under request



1E/6E 1E/7E 1E/10E

1E10

BIC® ROUND STIC®
1E10 Frosted

Ink Colour
● ● ●

Red Ink available under request



2E/6E 2E/7E 2E/3E 2E/10E

360° Printing

1:1 scale

1:1 scale

Only available on white barrel



MIX & MATCH



WRITING MODES



PRINTING TECHNIQUES



SUSTAINABILITY



ecolutions®



BIC GRAPHIC

BIC® WRITING INSTRUMENTS

OTHER WRITING INSTRUMENTS

NOTEBOOKS

BIC® / DIEEP® LIGHTERS AND BIC® CASES

BIC® PACKAGING

GENERAL INFORMATION

See pages 272-276 for a detailed explanation of the icons.

*The percentage is calculated based on total weight of the product excluding ink system. Due to the recycled content of the raw materials used to make the pen, we cannot guarantee that the colours shown in the catalogue or colours customised to order will always have the same colour and appearance.

BIC® ROUND STIC®

1010 / 1E10

BIC® ROUND STIC®

1010 / **ecolutions®** 1E10 Opaque
 1010 / **ecolutions®** 1E10 Frosted

MOQ 500 units.
 Standard colours combination



No extra charge

ecolutions®



Standard colours combination*

Plug

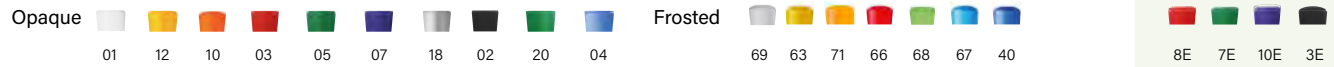
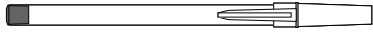

Cap

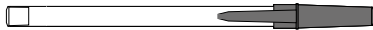

Section

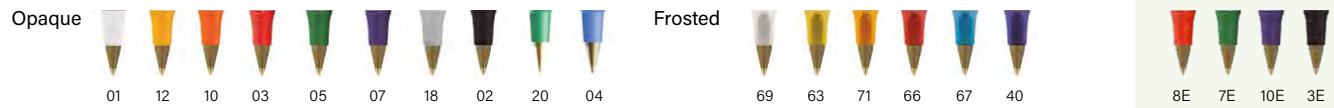
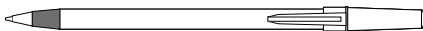

Barrel



Exact colour match: ≥ 10.000 units



**Excluding ink system
 Add the Möbius loop to your artwork at no additional charge. Please specify it on your order. (Möbius loop imprint defaults to left-hand corner.)

*Due to the recycled content of the raw materials used to make the product, we cannot guarantee that the colours shown in the catalogue or colours customised to order will always have the same colour and appearance.
 ** The percentage is calculated based on total weight of the product excluding ink system.

1010 / 1E10

BIC® ROUND STIC®

1010

ecolutions® 1E10

A SP: max. 3 col.

B SP: max. 1 col.

C SP: max. 1 col.

D DG: full-colour

(Only available on white barrel)

MOQ 500 units.

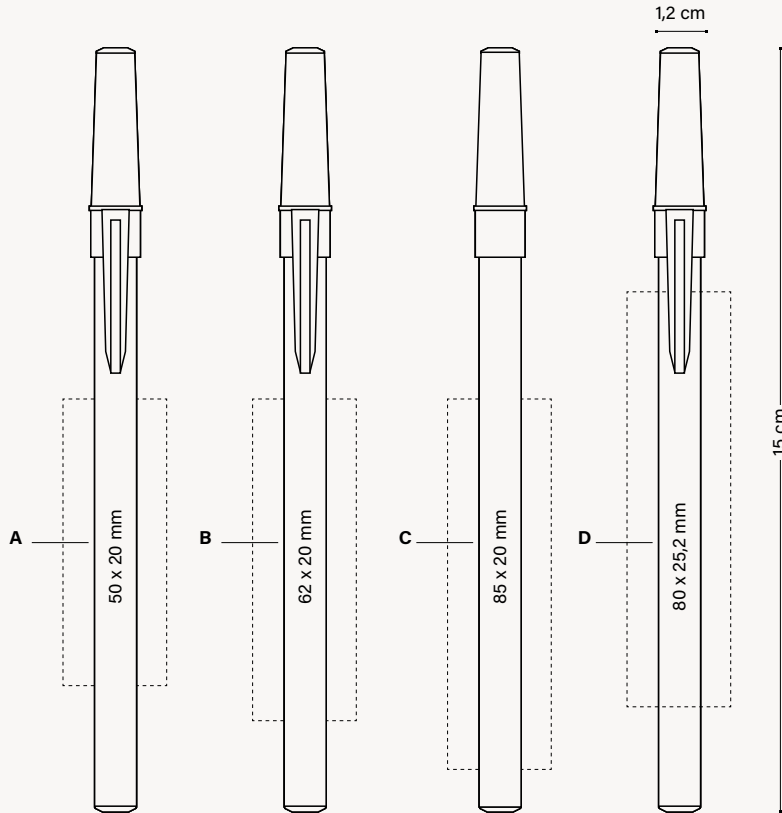

OPTIONAL SPECIAL PACKAGING



PLASTIC POUCH



BIC® COLLECTION BOX SLIM PENS 4 UNITS

+ INFO PAGES 254 TO 265

EXTERNAL PACKAGING



500 ± 2,5 KG

Can be used as bookmark



PERSONALISED COLOURS



MANUFACTURED AND PRINTED IN BIC FACTORIES



MADE IN SPAIN



REGULATORY COMPLIANCE



WRITING MODES



BALLPEN M Ø 1 MM

PRINTING TECHNIQUES



SCREEN PRINTING



DIGITAL

SUSTAINABILITY



IMPRIM'VERT®

ecolutions®



FRUIT AND VEGETABLE TRAYS



100% ELECTRICITY COMING FROM RENEWABLE SOURCES

BIC® M10® CLIC

Engineered for reliability. Proven for 70 years



Embossed
iconic BIC®
brand!

1590

BIC® M10® CLIC
1590

Ink Colour
●

NEW!

BIC® M10® CLIC PASTEL

MADE IN FRANCE

Side push
button



●
Only available
in black ink

1:1 scale

FR/
**Conçu pour
être fiable.**
Testé pendant 70 ans.

DE/
**Auf Zuverlässigkeit
ausgelegt.**
Seit 70 Jahren bewährt.

IT/
**Progettato per
garantire affidabilità.**
Comprovato da 70 anni.

ES/
**Diseñado para
ofrecer fiabilidad.**
Testado durante 70 años.

1590

BIC® M10® CLIC
1590

A SP: max. 2 col.

MOQ 500 units

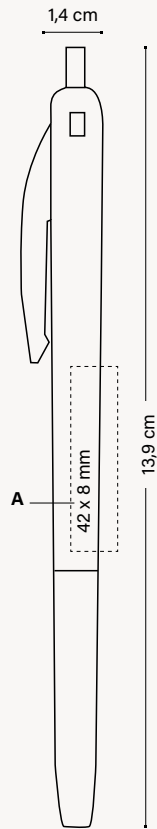

OPTIONAL SPECIAL PACKAGING



+ INFO PAGES 254 TO 265

*Can be used
as bookmark*

EXTERNAL PACKAGING



WRITING MODES



PRINTING TECHNIQUES



SUSTAINABILITY



CHECK OUT THE VIDEO



One of the bestsellers in the industry.

With its functional and widely recognized design, our BIC® Media Clic is a long lasting product available in different materials. Choose between the Standard, Recycled, Biobased, Antibacterial and premium finishes.

Be inspired with the wide range of finishes and colours, and match them to enhance your brand.

FR/

Notre BIC® Media Clic, un best-seller de l'industrie

Au design fonctionnel et largement reconnu, c'est un produit durable disponible dans différents matériaux. Choisissez parmi le Standard, Recyclé, Biobased, Antibactérien et finitions premium.

Laissez-vous inspirer par la vaste gamme de finitions et de couleurs, et associez-les pour mettre en valeur votre marque.

DE/

Einer der Bestseller in der Werbeartikelindustrie.

Funktional und mit hohem Wiedererkennungswert. Unser BIC® Media Clic ist ein langlebiges Produkt, erhältlich in verschiedensten Materialien. Wählen Sie zwischen Standard-, Recycelten-, Biobasierten-, Antibakteriellen- und Premium-Veredelungen.

Lassen Sie sich von einer Vielzahl an Ausführungen und Farben inspirieren und passen Sie ihn optimal an Ihre Marke an.

IT/

Uno dei bestseller del settore.

Dal design funzionale e ampiamente riconosciuto, la nostra BIC® Media Clic è un prodotto di lunga durata disponibile in diversi materiali. Scegli tra i modelli Standard, Riciclato, Biobased, Antibatterico e finiture premium.

Lasciati ispirare dall'ampia gamma di finiture e colori e abbinali per valorizzare il tuo marchio.

ES/

Uno de los más vendidos en la industria.

Con un diseño funcional y ampliamente reconocido, nuestro BIC® Media Clic es un producto duradero disponible en diferentes materiales. Elige entre estándar, reciclado, de material biológico, antibacteriano y acabados premium.

Déjate inspirar por la amplia gama de acabados y colores, y combínalos para realzar tu marca.

BIC® MEDIA CLIC FAMILY



1035
BIC® Media Clic
Advance



1025
BIC® Media Clic
Opaque



1025
BIC® Media Clic
Frosted



1E25
BIC® Media Clic
Ecolutions®



1E29
BIC® Media Clic
Ecolutions® Plus



1020
BIC® Media Clic
Grip Frosted



1E20
BIC® Media Clic
Grip Ecolutions®



1026
BIC® Media Clic BGuard™
Antibacterial



1E26
BIC® Media Clic BGuard™
Antimicrobial Ecolutions®



1972
BIC® Media Clic Biobased
Ecolutions®



1973
BIC® Media Clic Biobased
BGuard™ Antibacterial



1975
BIC® Media Clic Shine



1930
BIC® Media Clic Glacé

BIC®
GRAPHIC

BIC®
WRITING INSTRUMENTS

OTHER WRITING
INSTRUMENTS

NOTEBOOKS

BIC® / DIEEP® LIGHTERS
AND BIC® CASES

BIC®
PACKAGING

GENERAL
INFORMATION

1035

BIC® MEDIA CLIC ADVANCE

1035 Ballpen
Opaque

Ink Colour



NEW!

*Metal
section!*

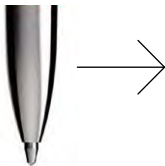

35



01 / 35



03 / 35



07 / 35



06 / 35



02 / 35



**Refill
service on
request**

1:1 scale

BIC® MEDIA CLIC ADVANCE

1035

BIC® MEDIA CLIC ADVANCE

1035 Ballpen

A SP: max. 4 col.

B SP: max. 2 col.

MOQ 500 units.

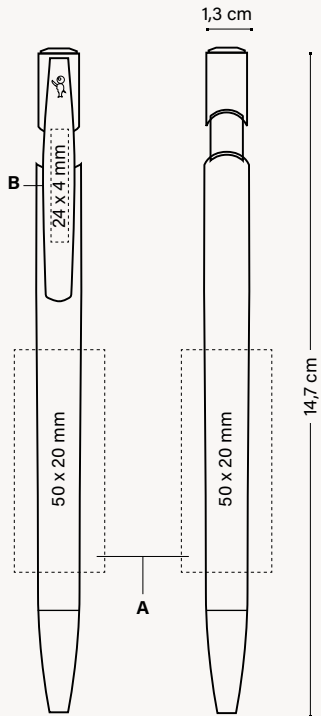

OPTIONAL SPECIAL PACKAGING



ECO SLEEVE

+ INFO PAGES 254 TO 265



PLASTIC POUCH

Can be used as bookmark



WINDOW BOX

EXTERNAL PACKAGING



500 ± 6,5 KG

Plug

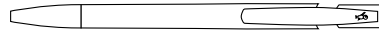

Opaque

01 03 07 06 02

Clip

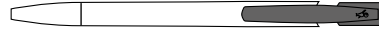

Opaque

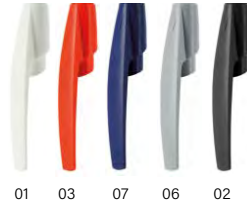

Barrel



Opaque

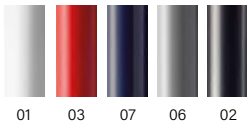

Section



Silver



35



MANUFACTURED AND PRINTED IN BIC FACTORIES



MADE IN SPAIN



REGULATORY COMPLIANCE



ISO certified

WRITING MODES



BALLPEN M 0.1 MM

PRINTING TECHNIQUES



SCREEN PRINTING

SUSTAINABILITY



IMPRIM'VERT®



100% ELECTRICITY COMING FROM RENEWABLE SOURCES

BIC GRAPHIC

BIC® WRITING INSTRUMENTS

OTHER WRITING INSTRUMENTS

NOTEBOOKS

BIC® / DIEEP® LIGHTERS AND BIC® CASES

BIC® PACKAGING

GENERAL INFORMATION

See pages 272-276 for a detailed explanation of the icons.

1025

Embossed
iconic
BIC® brand!

Also in
Mechanical
pencil

BIC® MEDIA CLIC

1025 Ballpen / 1028 Mechanical pencil (see page 172)

Opaque

Ink Colour



Red Ink available under request



ECO version and standard at the same price!

ecolutions®



MADE FROM 98% RECYCLED MATERIAL*
*From barrel



PLASTIC CAR PARTS

1E25

BIC® MEDIA CLIC
1E25 Ballpen
Opaque

Ink Colour



MIX & MATCH



PERSONALISED COLOURS



MANUFACTURED AND PRINTED IN BIC FACTORIES



MADE IN SPAIN



REGULATORY COMPLIANCE



ISO certified

WRITING MODES



BALLPEN M 0.1 MM

PRINTING TECHNIQUES



SCREEN PRINTING



DIGITAL

SUSTAINABILITY



ecolutions®



PLASTIC CAR PARTS



100% ELECTRICITY COMING FROM RENEWABLE SOURCES

*The percentage is calculated based on total weight of the barrel. Due to the recycled content of the raw materials used to make the product, we cannot guarantee that the colours shown in the catalogue or colours customised to order will always have the same colour and appearance.

BIC® MEDIA CLIC ECOLUTIONS® PLUS

98% Recycled*

*All external parts are made from 98% recycled material, thanks to the new clip.

Unbreakable clip,
now made from
recycled material.

FR/
98% recyclé*

*Toutes les parties externes sont fabriquées à partir de 98% de matériaux recyclés, grâce au nouveau clip.

DE/
98% recycelt*

*Alle äußeren Teile bestehen zu 98% aus recyceltem Material, dank des neuen Clips.

IT/
Riciclata al 98%*

*Tutte le parti esterne sono realizzate con il 98% di materiale riciclato, grazie alla nuova clip.

ES/
98% reciclado*

*Todas las partes exteriores están fabricadas con un 98 % de material reciclado, gracias al nuevo clip.

98% recycled*



FR/
Clip incassable,
désormais fabriqué à partir
de matériaux recyclés.

DE/
Bruchsicherer Clip, jetzt
aus recyceltem Material
hergestellt.

IT/
Clip infrangibile, ora
realizzata con materiale
riciclato.

ES/
Clip irrompible, ahora
fabricado con material
reciclado.

BIC® MEDIA CLIC ECOLUTIONS® PLUS

ECO version and standard at the same price!

ecolutions®
 **MADE FROM 98% RECYCLED MATERIAL***
 *excl. ink system

PLASTIC CAR PARTS

1E29

BIC® MEDIA CLIC ECOLUTIONS® PLUS

1E29

Opaque

Ink Colour



Red Ink available under request



1E

3E

1E

3E

1:1 scale

MIX & MATCH

MANUFACTURED AND PRINTED IN BIC FACTORIES

MADE IN SPAIN

REGULATORY COMPLIANCE

ISO certified

WRITING MODES

BALLPEN M
0.1 MM

PRINTING TECHNIQUES

SP
SCREEN PRINTING

DG
DIGITAL

SUSTAINABILITY

IMPRIM'VERT®

ecolutions®

PLASTIC CAR PARTS

100% ELECTRICITY COMING FROM RENEWABLE SOURCES

BIC GRAPHIC

BIC® WRITING INSTRUMENTS

OTHER WRITING INSTRUMENTS

NOTEBOOKS

BIC® / DIEEP® LIGHTERS AND BIC® CASES

BIC® PACKAGING

GENERAL INFORMATION

*The percentage is calculated based on total weight of the pen excluding ink system. Due to the recycled content of the raw materials used to make the product, we cannot guarantee that the colours shown in the catalogue or colours customised to order will always have the same colour and appearance.

1025



Embossed
iconic
BIC® brand!



Also in
Mechanical
pencil

BIC® MEDIA CLIC

1025 Ballpen / 1028 Mechanical pencil (see page 172)

Frosted

Ink Colour



Red Ink available under request



1020 / 1021

 Embossed iconic BIC® brand!

 Also in Mechanical pencil

BIC® MEDIA CLIC GRIP

1020 Ballpen

1021 Mechanical pencil (see page 173)

Frosted

Ink Colour



01/69



71/69



82/69



40/69

1:1 scale

MIX & MATCH



PERSONALISED COLOURS



MANUFACTURED AND PRINTED IN BIC FACTORIES



MADE IN SPAIN



REGULATORY COMPLIANCE



ISO certified

WRITING MODES



BALLPEN M 0.1 MM

PRINTING TECHNIQUES



SCREEN PRINTING



DIGITAL

SUSTAINABILITY



IMPRIM'VERT®



100% ELECTRICITY COMING FROM RENEWABLE SOURCES

BIC GRAPHIC

BIC® WRITING INSTRUMENTS

OTHER WRITING INSTRUMENTS

NOTEBOOKS

BIC® / DIEEP® LIGHTERS AND BIC® CASES

BIC® PACKAGING

GENERAL INFORMATION

See pages 272-276 for a detailed explanation of the icons.

MIX & MATCH



PERSONALISED COLOURS



MANUFACTURED AND PRINTED IN BIC FACTORIES



MADE IN SPAIN



REGULATORY COMPLIANCE



WRITING MODES



BALLPEN M 0.1 MM

PRINTING TECHNIQUES



SCREEN PRINTING



DIGITAL

SUSTAINABILITY



IMPRIM'VERT®

ecolutions®



PLASTIC CAR PARTS



100% ELECTRICITY COMING FROM RENEWABLE SOURCES



Embossed iconic BIC® brand!



Also in Mechanical pencil

ECO version and standard at the same price!

ecolutions®



MADE FROM 98% RECYCLED MATERIAL*
*From barrel



PLASTIC CAR PARTS

1E20 / 1E21

BIC® MEDIA CLIC GRIP

1E20 Ballpen

1E21 Mechanical pencil (see page 173)

Opaque

Ink Colour



01/03



01/05



01/02



01/07

1:1 scale

MIX & MATCH No extra charge

MOQ 500 units
ecolutions® Standard colours combination

Plug



Opaque



Frosted



Clip

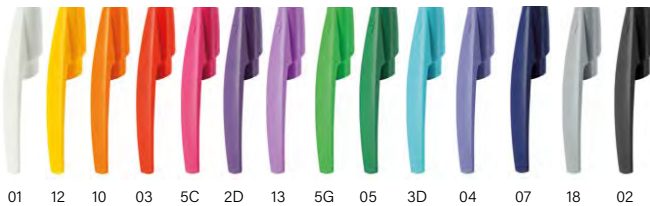
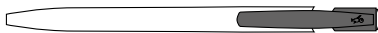

Opaque



Barrel



Opaque

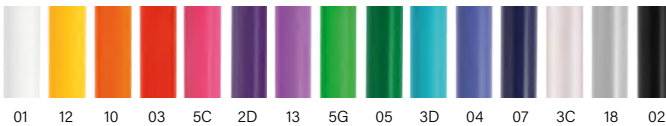

Frosted

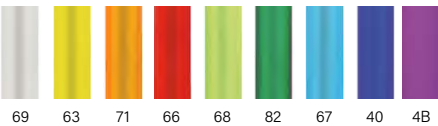

Barrel & Grip

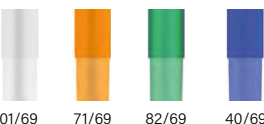

Exact colour match: \geq 10.000 units 1025/1E25
Exact colour match: \geq 20.000 units 1020/1E20



ecolutions®



PLASTIC CAR PARTS

Standard colours combination*

Opaque



Barrel & Grip
Opaque



*From barrel

Add the Möbius loop to your artwork at no additional charge. Please specify "Print the Möbius loop" on your order. (Möbius loop imprint defaults to left-hand corner.)

MIX & MATCH
ecolutions®



PERSONALISED COLOURS



MANUFACTURED AND PRINTED IN BIC FACTORIES

PRINTING TECHNIQUES



SCREEN PRINTING



DIGITAL

WRITING MODES



BALLPEN M
Ø 1 MM

SUSTAINABILITY



PLASTIC CAR PARTS

1025 / 1028 / 1E25 / 1E29

BIC® MEDIA CLIC

1025 Ballpen
 1028 Mechanical pencil (see page 172)
 1E25 Ballpen **ecolutions®**
 1E29 Ballpen **ecolutions® Plus**

A SP: max. 4 col.
B SP: max. 2 col.
C DG: full-colour

MOQ 500 units.

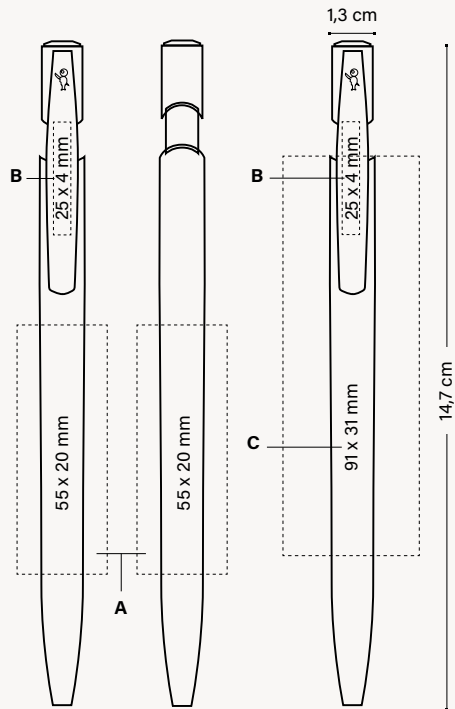

OPTIONAL SPECIAL PACKAGING

EXTERNAL PACKAGING



ECO SLEEVE



PLASTIC POUCH



WINDOW BOX



500 ± 4,1 KG

+ INFO PAGES 254 TO 265

Can be used as bookmark



MANUFACTURED AND PRINTED IN BIC FACTORIES

MADE IN SPAIN

PRINTING TECHNIQUES

- SP** SCREEN PRINTING
- DG** DIGITAL

WRITING MODES

- U** BALLPEN M Ø 1MM

SUSTAINABILITY



1020 / 1E20 / 1021 / 1E21

BIC® MEDIA CLIC GRIP

1020 Ballpen
1021 Mechanical pencil
(see page 173)

ecolutions® 1E20 Ballpen
ecolutions® 1E21 Mechanical pencil
(see page 173)

D SP: max. 4 col.

E SP: max. 2 col.

F DG: full-colour

MOQ 500 units.

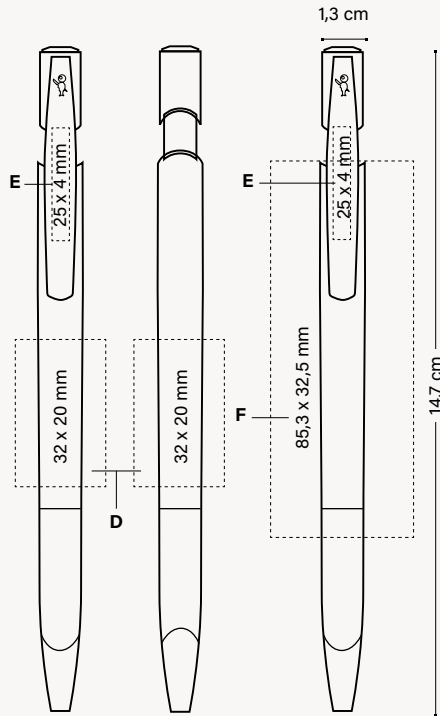

OPTIONAL SPECIAL PACKAGING

EXTERNAL PACKAGING



ECO SLEEVE

+ INFO PAGES 254 TO 265



PLASTIC POUCH

*Can be used
as bookmark*



WINDOW BOX



500 ± 4,3 KG



MANUFACTURED
AND PRINTED IN
BIC FACTORIES



MADE
IN SPAIN

PRINTING TECHNIQUES

- SP** SCREEN PRINTING
- DG** DIGITAL

WRITING MODES

- BALLPEN M** 0.1 MM

SUSTAINABILITY

- PLASTIC CAR PARTS**

See pages 272-276 for a detailed explanation of the icons.

BIC® MEDIA CLIC BGUARD™ ANTIBACTERIAL

BGUARD™



Bacteria elimination



Entire pen protection



Timeless protection



Antibacterial Test protocol

1026

BIC® MEDIA CLIC BGUARD™ ANTIBACTERIAL

1026: antibacterial logo
Opaque

Ink Colour



Red Ink available under request



1BG

2BG

MIX & MATCH

No extra charge

MOQ 500 units
Standard colours combination

Plug

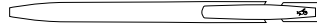

Opaque 1BG 2BG

Clip



Opaque 1BG 2BG

Barrel



Opaque 1BG 2BG

Exact colour match: > 10.000 units



Iconic BIC® Boy and Antibacterial logo always visible!

ANTIBACTERIAL™

BIC® MEDIA CLIC BGUARD™ ANTIBACTERIAL

1026

BIC® MEDIA CLIC BGUARD™ ANTIBACTERIAL

1026: antibacterial logo

A SP: max. 2 col.
B SP: max. 1 col.

MOQ 500 units.

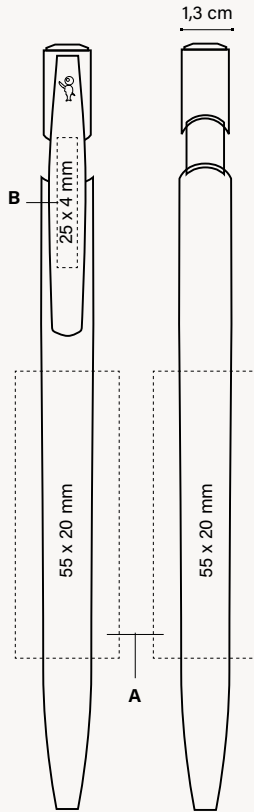

OPTIONAL SPECIAL PACKAGING



ECO SLEEVE

+ INFO PAGES 254 TO 265



PLASTIC POUCH

*Can be used
as bookmark*



WINDOW BOX

EXTERNAL PACKAGING



500 ± 4,1 KG

MIX & MATCH



PERSONALISED COLOURS



MANUFACTURED AND PRINTED IN BIC FACTORIES



MADE IN SPAIN



REGULATORY COMPLIANCE



ISO certified

WRITING MODES



BALLPEN M
Ø 1 MM

PRINTING TECHNIQUES



SCREEN PRINTING

SUSTAINABILITY



IMPRIM'VERT®



100% ELECTRICITY COMING FROM RENEWABLE SOURCES

BIC
GRAPHIC

BIC®
WRITING INSTRUMENTS

OTHER WRITING
INSTRUMENTS

NOTEBOOKS

BIC® / DIEEP® LIGHTERS
AND BIC® CASES

BIC®
PACKAGING

GENERAL
INFORMATION

See pages 272-276 for a detailed explanation of the icons.

BIC® MEDIA CLIC BGUARD™ ANTIMICROBIAL ECOLUTIONS®



ANTIMICROBIAL™* =



Bacteria elimination
99% in 24h

+



Viral reduction
93% in 24 h

+



Fungal inhibition
for 24 h

BGUARD™

ecolutions®



MADE FROM 98%
RECYCLED MATERIAL**
**From barrel



1E26

BIC® MEDIA CLIC BGUARD™ ANTIMICROBIAL ECOLUTIONS®

ecolutions® 1E26: antimicrobial logo
Opaque

Ink Colour



Red Ink available
under request



MIX & MATCH No extra charge



Add the Möbius loop to your artwork at no additional charge. Please specify it on your order. (Möbius loop imprint defaults to left-hand corner.)

**From barrel

MOQ 500 units
Standard colours combination

Plug



Opaque 1BG 2BG

Clip

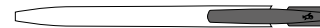

Opaque 1BG 2BG

Barrel



Opaque 1E 3E

Exact colour match: ≥ 10.000 units



*99.9% of bacteria is eliminated from the surface in 24 hours (and more than 30% in 2 hours).
Tested under ISO 22196 protocol adapted to real usage of the pen.

93% of viruses, Sars-Cov-2 Coronavirus causing Covid-19 disease, are eliminated from the surface in 24 hours, (and around 50% in 2 hours).
Tested under ISO 22196 protocol adapted to real usage of the pen.

Fungi present on the surface is inhibited within 24 hours.

Tested under ISO 22196 protocol adapted to fungi and to real usage of the pen.

** The percentage is calculated based on total weight of the barrel. Due to the recycled content of the raw materials used to make the product, we cannot guarantee that the colours shown in the catalogue or colours customised to order will always have the same colour and appearance.

BIC® MEDIA CLIC BGUARD™ ANTIMICROBIAL ECOLUTIONS®



Entire pen protection



Timeless protection



Antibacterial Test protocol



Adapted to fungus test protocol



Antiviral test protocol



PERSONALISED COLOURS



MANUFACTURED AND PRINTED IN BIC FACTORIES



MADE IN SPAIN



REGULATORY COMPLIANCE



WRITING MODES



BALLPEN M 0.1 MM

PRINTING TECHNIQUES



SCREEN PRINTING

SUSTAINABILITY



ecolutions®



PLASTIC CAR PARTS



100% ELECTRICITY COMING FROM RENEWABLE SOURCES

1E26

BIC® MEDIA CLIC BGUARD™ ANTIMICROBIAL ECOLUTIONS®

ecolutions® 1E26: antimicrobial logo

A SP: max. 2 col.

B SP: max. 2 col.

MOQ 500 units.

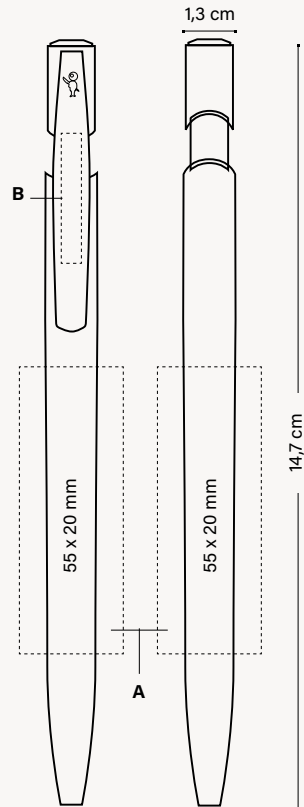

OPTIONAL SPECIAL PACKAGING



ECO SLEEVE

+ INFO PAGES 254 TO 265



PLASTIC POUCH

Can be used as bookmark



WINDOW BOX

EXTERNAL PACKAGING



500 ± 41 KG

BIC GRAPHIC

BIC WRITING INSTRUMENTS

OTHER WRITING INSTRUMENTS

NOTEBOOKS

BIC / DIEEP LIGHTERS AND BIC CASES

BIC PACKAGING

GENERAL INFORMATION

See pages 272-276 for a detailed explanation of the icons.



PERSONALISED COLOURS



MANUFACTURED AND PRINTED IN BIC FACTORIES



MADE IN SPAIN



REGULATORY COMPLIANCE



WRITING MODES



BALLPEN M 0.1 MM

PRINTING TECHNIQUES



SCREEN PRINTING



DIGITAL

SUSTAINABILITY



IMPRIM'VERT®

ecolutions®



SUGAR CANE



100% ELECTRICITY COMING FROM RENEWABLE SOURCES

BIOBASED ecolutions®

MADE FROM
69% BIO-SOURCED*
MATERIAL

1972

BIC® MEDIA CLIC BIOBASED ECOLUTIONS®

1972 Ballpen

Opaque

Ink Colour



Red Ink available under request



14A

4M

9C

12BIO

03BIO

04BIO

02BIO

05BIO

01BIO

1:1 scale

Available on white barrel



* The percentage is calculated based on total weight of the barrel. Due to the natural content of the raw materials used to make the product, we cannot guarantee that the colours shown in the catalogue or colours customised to order will always have the same colour and appearance.

BIC® MEDIA CLIC BIOBASED ECOLUTIONS®



SUGAR CANE

MIX & MATCH No extra charge

MOQ 500 units
Standard colours combination

Plug



Clip

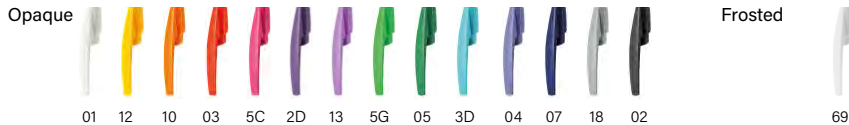

Barrel

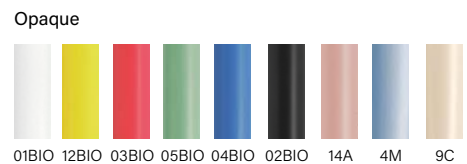

Exact colour match:
≥ 10.000 units

1972

BIC® MEDIA CLIC BIOBASED ECOLUTIONS®

1972

A SP: max. 2 col.
B SP: max. 2 col.
C DG: full-colour

MOQ 500 units.

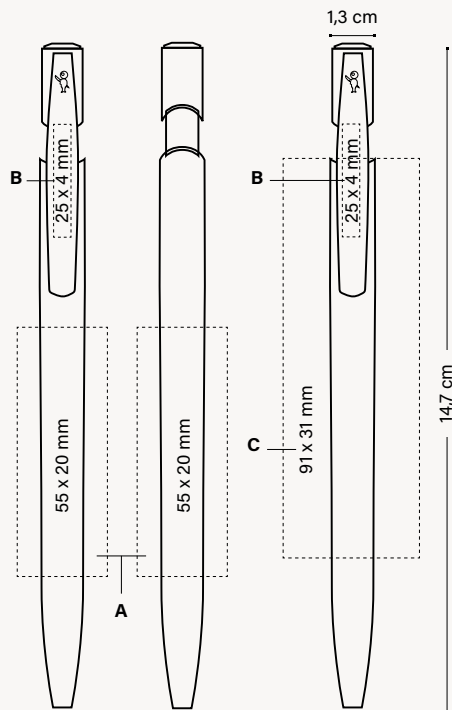

OPTIONAL SPECIAL PACKAGING



+ INFO PAGES 254 TO 265

Can be used as bookmark

EXTERNAL PACKAGING



WRITING MODES



PRINTING TECHNIQUES



SUSTAINABILITY



BIC GRAPHIC

BIC® WRITING INSTRUMENTS

OTHER WRITING INSTRUMENTS

NOTEBOOKS

BIC® / DEEPP® LIGHTERS AND BIC® CASES

BIC® PACKAGING

GENERAL INFORMATION

* Due to the natural content of the raw materials used to make the product, we cannot guarantee that the colours shown in the catalogue or colours customised to order will always have the same colour and appearance.

BIC® MEDIA CLIC BIOBASED BGUARD™ ANTIBACTERIAL

MIX & MATCH



PERSONALISED COLOURS



MANUFACTURED AND PRINTED IN BIC FACTORIES



MADE IN SPAIN



REGULATORY COMPLIANCE



WRITING MODES



BALLPEN M
Ø 1 MM

PRINTING TECHNIQUES



SCREEN PRINTING

SUSTAINABILITY



IMPRIM'VERT®



SUGAR CANE



100% ELECTRICITY COMING FROM RENEWABLE SOURCES

BGUARD™



Bacteria elimination



Entire pen protection



Timeless protection



Antibacterial Test protocol

BIOBASED ecolutions®

MADE FROM
69% **BIO-SOURCED***
MATERIAL

1973

BIC® MEDIA CLIC BIOBASED BGUARD™ ANTIBACTERIAL

1973 Ballpen
Opaque

Ink Colour
● ● ●

Red Ink available under request



02

01

1:1 scale

**The percentage is calculated based on total weight of the barrel. Due to the natural content of the raw materials used to make the product, we cannot guarantee that the colours shown in the catalogue or colours customised to order will always have the same colour and appearance.*

BIC® MEDIA CLIC BIOBASED BGUARD™ ANTIBACTERIAL



SUGAR CANE

MIX & MATCH No extra charge

MOQ 500 units. Standard colours combination.

Plug

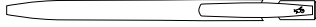

Opaque

01BG 02BG

Clip

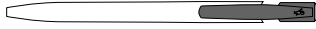

Opaque

01BG 02BG

Barrel



Opaque

01 02

Exact colour match: ≥ 10.000 units



1973

BIC® MEDIA CLIC BIOBASED BGUARD™ ANTIBACTERIAL

1973

A SP: max. 2 col.
B SP: max. 2 col.

MOQ 500 units.

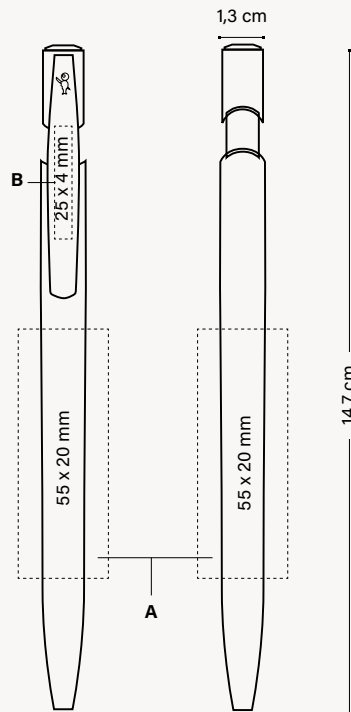

OPTIONAL SPECIAL PACKAGING

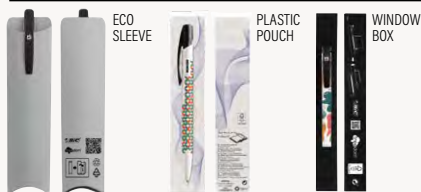

+ INFO PAGES 254 TO 265

Can be used as bookmark

EXTERNAL PACKAGING



PERSONALISED COLOURS



MANUFACTURED AND PRINTED IN BIC FACTORIES



MADE IN SPAIN

WRITING MODES



BALLPEN M
Ø 1 MM

PRINTING TECHNIQUES



SCREEN PRINTING

SUSTAINABILITY

ecolutions®



SUGAR CANE

BIC GRAPHIC

BIC® WRITING INSTRUMENTS

OTHER WRITING INSTRUMENTS

NOTEBOOKS

BIC® / BIC® LIGHTERS AND BIC® CASES

BIC® PACKAGING

GENERAL INFORMATION

See pages 272-276 for a detailed explanation of the icons.

*Due to the natural content of the raw materials used to make the product, we cannot guarantee that the colours shown in the catalogue or colours customised to order will always have the same colour and appearance. Available in selected countries, please ask your customer service representative.

1975

BIC® MEDIA CLIC SHINE
1975 Ballpen

Ink Colour
● ● ●

Red Ink available under request



47



26

1:1 scale

MIX & MATCH No extra charge

MOQ 500 units. Standard colours combination.

Plug



Clip

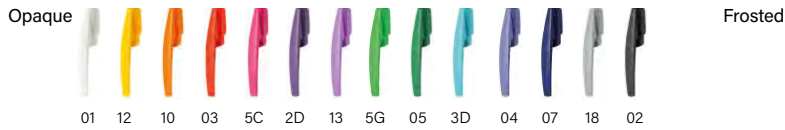
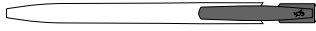

Barrel

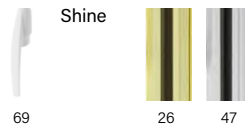

1975

BIC® MEDIA CLIC SHINE

1975

A SP: max. 2 col.

B SP: max. 2 col.

MOQ 500 units.

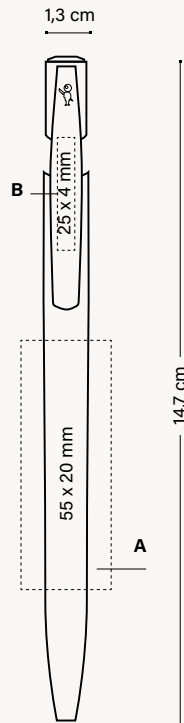

OPTIONAL SPECIAL PACKAGING



ECO SLEEVE

+ INFO PAGES 254 TO 265



PLASTIC POUCH

Can be used as bookmark



WINDOW BOX

EXTERNAL PACKAGING



500 ± 4,1 KG



WRITING MODES



PRINTING TECHNIQUES



SUSTAINABILITY



See pages 272-276 for a detailed explanation of the icons.

BIC® MEDIA CLIC GLACÉ

Our bestseller
in elegant colours.

Elegant
ballpen

1030

BIC® MEDIA CLIC GLACÉ
1030 Glacé

Ink Colour



Red Ink available under request



1:1 scale

FR/

Des couleurs élégantes
pour notre best-seller.

DE/

Elegante Farben für
unseren Bestseller.

IT/

Il nostro best seller
in abito elegante.

ES/

Colores elegantes en
nuestro best seller.

BIC® MEDIA CLIC GLACÉ

MIX & MATCH No extra charge

MOQ 500 units
Standard colours combination

Plug

Opaque 01 12 10 03 5C 2D 13 84 5G 05 3D 04 07 18 02 Frosted 69

Clip

Opaque 01 12 10 03 5C 2D 13 5G 05 3D 04 07 18 02 Frosted 69

Barrel

Glacé 47G 76 03G 14G 05G 04G

1030

BIC® MEDIA CLIC GLACÉ

1030

A SP: max. 2 col.

B SP: max. 2 col.

MOQ 500 units.

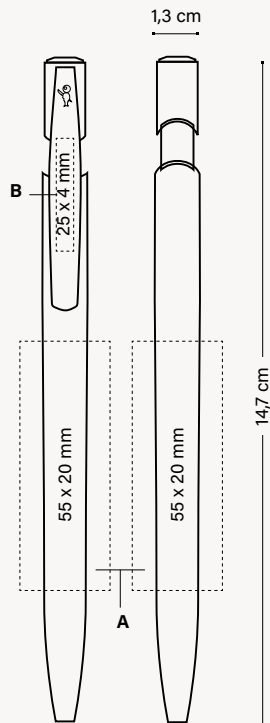

OPTIONAL SPECIAL PACKAGING



+ INFO PAGES 254 TO 265



Can be used as bookmark



EXTERNAL PACKAGING



SUSTAINABILITY



BIC® GRAPHIC

BIC® WRITING INSTRUMENTS

OTHER WRITING INSTRUMENTS

NOTEBOOKS

BIC® / DIEEP® LIGHTERS AND BIC® CASES

BIC® PACKAGING

GENERAL INFORMATION

See pages 272-276 for a detailed explanation of the icons.

BIC® CLIC STIC

Modern design, practical comfort, reliable performance. That's the BIC® Clic Stic!

FR /
Moderne, pratique, fiable.
Le BIC® Clic Stic est ainsi!

DE /
Modern, praktisch, zuverlässig.
So ist der BIC® Clic Stic!

IT /
Moderna, pratico, affidabile.
Ecco com'è BIC® Clic Stic !

ES /
Moderno, práctico, fiable.
¡Así es BIC® Clic Stic!

→
Multiple colour combinations

Lots of colours
to choose and
versions to assemble

→
Touch tip



BIC® CLIC STIC

ECO version and standard at the same price!

ecolutions®



MADE FROM **87% RECYCLED MATERIAL***
*Excluding ink system

FRUIT AND VEGETABLE TRAYS



MIX & MATCH



PERSONALISED COLOURS



MANUFACTURED AND PRINTED IN BIC FACTORIES



MADE IN SPAIN



REGULATORY COMPLIANCE



WRITING MODES



BALLPEN M 0.1 MM

PRINTING TECHNIQUES



SCREEN PRINTING



DIGITAL

SUSTAINABILITY



IMPRIM'VERT®



FRUIT AND VEGETABLE TRAYS



100% ELECTRICITY COMING FROM RENEWABLE SOURCES

1000

Iconic BIC® Boy is embossed

BIC® CLIC STIC
1000 Opaque

Ink Colour
● ● ●



360° Printing

1:1 scale

Available on white barrel



1E00

BIC® CLIC STIC
1E00 Opaque

Ink Colour
● ● ●



360° Printing

1:1 scale

Available on white barrel



BIC GRAPHIC

BIC® WRITING INSTRUMENTS

OTHER WRITING INSTRUMENTS

NOTEBOOKS

BIC® / DIEEP® LIGHTERS AND BIC® CASES

BIC® PACKAGING

GENERAL INFORMATION

See pages 272-276 for a detailed explanation of the icons.

*The percentage is calculated based on total weight of the pen excluding ink system. Due to the recycled content of the raw materials used to make the product, we cannot guarantee that the colours shown in the catalogue or colours customised to order will always have the same colour and appearance.

ECO version and standard at the same price!

ecolutions®



MADE FROM **87% RECYCLED MATERIAL***

*Excluding ink system



FRUIT AND VEGETABLE TRAYS

1000

BIC® CLIC STIC
1000 Frosted

Ink Colour
● ● ●

Red Ink available under request



1E00

BIC® CLIC STIC
1E00 Frosted

Ink Colour
● ● ●

Red Ink available under request



*The percentage is calculated based on total weight of the pen excluding ink system. Due to the recycled content of the raw materials used to make the product, we cannot guarantee that the colours shown in the catalogue or colours customised to order will always have the same colour and appearance.

1005

**BIC® CLIC STIC
SOFTFEEL®**
1005 Opaque

Ink Colour
● ● ●

*Red Ink available
under request*



20



07



02

1:1 scale

1005

**BIC® CLIC STIC
SOFTFEEL®**
1005 Frosted

Ink Colour
● ● ●

*Red Ink available
under request*



40

1:1 scale

**MIX &
MATCH**



PERSONALISED
COLOURS



MANUFACTURED
AND PRINTED IN
BIC FACTORIES



MADE IN SPAIN



REGULATORY
COMPLIANCE



**WRITING
MODES**



BALLPEN M
Ø 1 MM

**PRINTING
TECHNIQUES**



SCREEN PRINTING



DIGITAL

SUSTAINABILITY



IMPRIM'VERT®

ecolutions®



FRUIT AND
VEGETABLE TRAYS



100% ELECTRICITY
COMING FROM
RENEWABLE SOURCES

See pages 272-276 for a detailed explanation of the icons.

MIX & MATCH



PERSONALISED COLOURS



MANUFACTURED AND PRINTED IN BIC FACTORIES



MADE IN SPAIN



REGULATORY COMPLIANCE



WRITING MODES



BALLPEN M 0.1 MM

PRINTING TECHNIQUES



SCREEN PRINTING



DIGITAL

SUSTAINABILITY



IMPRIM'VERT®



FRUIT AND VEGETABLE TRAYS



100% ELECTRICITY COMING FROM RENEWABLE SOURCES

ECO version and standard at the same price!

ecolutions®



MADE FROM 87% RECYCLED MATERIAL*

*Excluding ink system



FRUIT AND VEGETABLE TRAYS

1847

BIC® CLIC STIC STYLUS
1847 Opaque

Ink Colour
● ● ●

Red Ink available under request



1:1 scale

1846

BIC® CLIC STIC STYLUS
1846 Opaque

Ink Colour
● ● ●

Red Ink available under request



1:1 scale

*The percentage is calculated based on total weight of the pen excluding ink system. Due to the recycled content of the raw materials used to make the product, we cannot guarantee that the colours shown in the catalogue or colours customised to order will always have the same colour and appearance.

MOQ 500 units. Standard colours combination

Plug

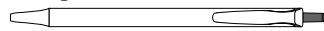

Opaque



Frosted

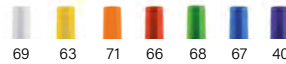

Clip

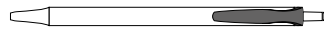

Opaque



Frosted



Section

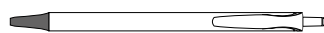

Opaque



Frosted

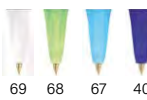

Stylus

Opaque



Barrel



Opaque

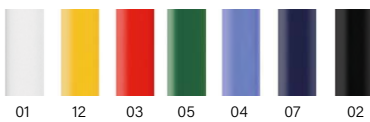

Stylus

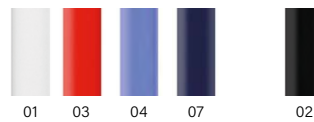

Softfeel®

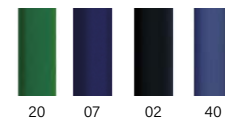

Frosted

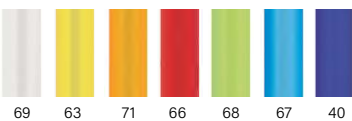

Exact colour match: ≥ 10.000 units

ecolutions®

MOQ 500 units
ecolutions® Standard colours combination**



Add the Möbius loop to your artwork at no additional charge. Please specify it on your order. (Möbius loop imprint defaults to left-hand corner.)

*Excluding ink system

FRUIT AND VEGETABLE TRAYS



Plug



Opaque



Section



Opaque



Stylus

Opaque



Clip



Opaque



Barrel



Opaque

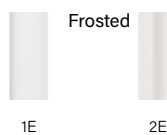

Frosted

Stylus

Opaque



Exact colour match: ≥ 10.000 units

**Due to the recycled content of the raw materials used to make the product, we cannot guarantee that the colours shown in the catalogue or colours customised to order will always have the same colour and appearance.



PERSONALISED COLOURS



MANUFACTURED AND PRINTED IN BIC FACTORIES



MADE IN SPAIN



REGULATORY COMPLIANCE



WRITING MODES



BALLPEN M 0.1 MM

PRINTING TECHNIQUES



SCREEN PRINTING



DIGITAL

SUSTAINABILITY



IMPRIM'VERT®



FRUIT AND VEGETABLE TRAYS



100% ELECTRICITY COMING FROM RENEWABLE SOURCES

1000 / 1E00 / 1847 / 1846

BIC® CLIC STIC

1000 / **ecolutions®** 1E00

BIC® CLIC STIC STYLUS

1847 / **ecolutions®** 1846

A SP: max. 3 col.

B SP: max. 1 col.

C SP: max. 2 col.

D DG: full-colour (area for text)
(Only available on white barrel)

MOQ 500 units.

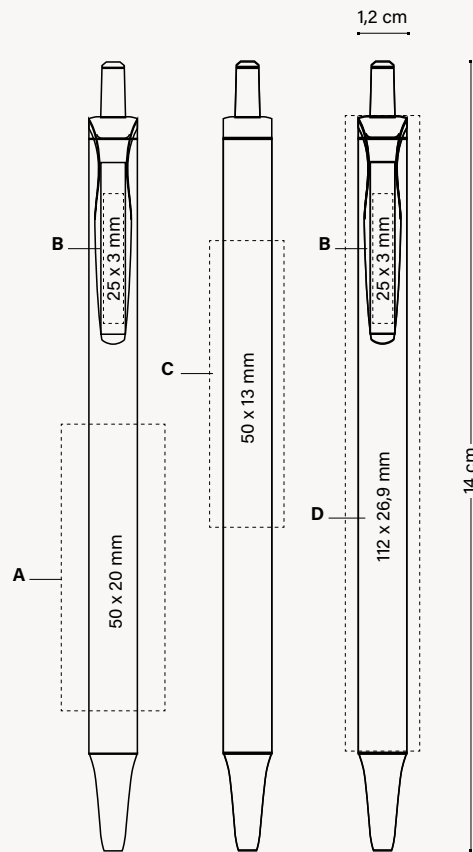

OPTIONAL SPECIAL PACKAGING



ECO SLEEVE

+ INFO PAGES 254 TO 265



PLASTIC POUCH

Can be used as bookmark

EXTERNAL PACKAGING



500 ± 2,9 KG

1005

BIC® CLIC STIC SOFTFEEL®
1005

A/B SP: max. 1 col.

MOQ 500 units.

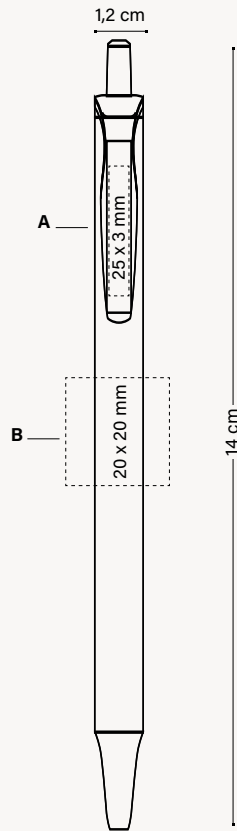

OPTIONAL SPECIAL PACKAGING



ECO SLEEVE



PLASTIC POUCH



BIC® COLLECTION
BOX SLIM PENS
4 UNITS

+ INFO PAGES 254 TO 265

*Can be used
as bookmark*

EXTERNAL PACKAGING



500 ± 2,9 KG

MIX & MATCH



PERSONALISED COLOURS



MANUFACTURED AND PRINTED IN BIC FACTORIES



MADE IN SPAIN



REGULATORY COMPLIANCE



ISO certified

WRITING MODES



BALLPEN M
0.1 MM

PRINTING TECHNIQUES



SCREEN PRINTING



DIGITAL

SUSTAINABILITY



IMPRIM'VERT®



100% ELECTRICITY
COMING FROM
RENEWABLE SOURCES

BIC
GRAPHIC

BIC®
WRITING INSTRUMENTS

OTHER WRITING
INSTRUMENTS

NOTEBOOKS

BIC® / DIIPEE® LIGHTERS
AND BIC® CASES

BIC®
PACKAGING

GENERAL
INFORMATION

See pages 272-276 for a detailed explanation of the icons.



Discover the eye-catching clip and its reliable twist mechanism.

Large printing areas offer a wide range of personalisation possibilities in the standard and Advance versions. Also available in Soft and Glacé versions.

In addition, the BIC® Super Clip Origin is a more innovative and sustainable ballpen.

FR/

Découvrez le clip attrayant et son mécanisme pivotant fiable.

La grande zone d'impression XXL offre une vaste gamme de possibilités de personnalisation dans la version Standard et Advance. Également dans les versions Soft et Glacé.

De plus, le BIC® Super Clip Origin est un stylo à bille plus innovant et plus durable.

DE/

Entdecken Sie den auffälligen Clip und seinen zuverlässigen Drehmechanismus.

Der XXL-Druckbereich bietet vielseitige Personalisierungsmöglichkeiten bei der Standard und Advance-Version. Auch als Soft- und Glacé-Version erhältlich.

Darüber hinaus ist der BIC® Super Clip Origin ein innovativerer und nachhaltigerer Kugelschreiber.

IT/

Scopri l'accattivante clip e il suo fluido meccanismo

affidabile. La grande area di stampa XXL offre un'ampia gamma di possibilità di personalizzazione nelle versioni standard e advance. Ora disponibile anche nelle versioni soft e glacé.

Inoltre, la BIC® Super Clip Origin è una penna a sfera più innovativa e sostenibile.

ES/

Descubre el llamativo clip y su mecanismo giratorio fiable.

La gran área de marcaje XXL ofrece una amplia variedad de posibilidades de personalización en la versión estándar y advance. Ahora también en las versiones soft y glacé.

Además, el BIC® Super Clip Origin es un bolígrafo más innovador y sostenible.



1E50
BIC® Super Clip Ecolutions®



1039
BIC® Super Clip



1073
BIC® Super Clip Advance



1082
BIC® Super Clip Glacé

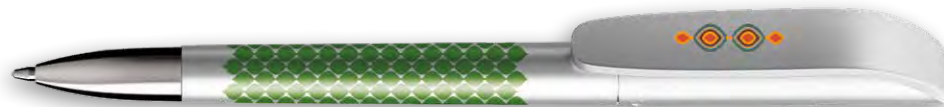

1084
BIC® Super Clip Glacé Advance



1083
BIC® Super Clip Soft



1085
BIC® Super Clip Soft Advance



1038
BIC® Super Clip Origin

A large clip to personalise

1039

BIC® SUPER CLIP
1039 Opaque

Ink Colour
● ●



Large
printing
areas!



Reliable twist
mechanism!

360°
Printing

1:1 scale

Available on
white barrel



BIC® SUPER CLIP

ECO version and standard at the same price!

ecolutions®



MADE FROM **90% RECYCLED MATERIAL***
*Excluding ink system



PLASTIC CAR PARTS

1E50

BIC® SUPER CLIP
1E50 Opaque

Ink Colour



1E

171 scale

1039

BIC® SUPER CLIP
1039 Clear

Ink Colour



51

87

86

89

88

171 scale

MIX & MATCH



PERSONALISED COLOURS



MANUFACTURED AND PRINTED IN BIC FACTORIES



MADE IN SPAIN



REGULATORY COMPLIANCE



ISO certified

WRITING MODES



BALLPEN M
Ø 1 MM

PRINTING TECHNIQUES



SCREEN PRINTING



DIGITAL



BRITEPIX™
BRITEPIX™ TEXTURE
BRITEPIX™ PERSONALISATION

SUSTAINABILITY



ecolutions®



PLASTIC CAR PARTS



100% ELECTRICITY
COMING FROM
RENEWABLE SOURCES

BIC®
GRAPHIC

BIC®
WRITING INSTRUMENTS

OTHER WRITING
INSTRUMENTS

NOTEBOOKS

BIC® / DIEEP® LIGHTERS
AND BIC® CASES

BIC®
PACKAGING

GENERAL
INFORMATION

See pages 272-276 for a detailed explanation of the icons.

*The percentage is calculated based on total weight of the pen excluding ink system. Due to the recycled content of the raw materials used to make the product, we cannot guarantee that the colours shown in the catalogue or colours customised to order will always have the same colour and appearance.

BIC® SUPER CLIP

1039 / 1E50

BIC® SUPER CLIP

1039 Opaque

ecolutions® 1E50 Opaque

1039 Clear

MOQ 250 units

Standard colours combination

MIX & MATCH No extra charge

Clip

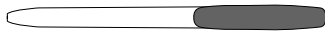

Opaque



Clear

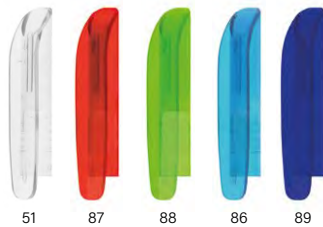

ecolutions®



Standard colours combination*



*Excluding ink system

Add the Möbius loop to your artwork at no additional charge. Please specify it on your order. (Möbius loop imprint defaults to left-hand hand corner.)

Barrel



Opaque

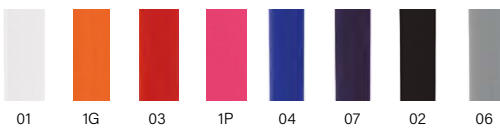

Clear

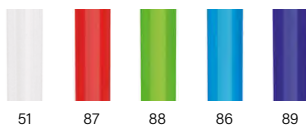

Exact colour match: ≥ 10.000 units



BIC® SUPER CLIP

1039 / 1E50

BIC® SUPER CLIP

1039

ecolutions® 1E50

A SP: max. 2 col.

B SP: max. 1 col.

C DG: full-colour

D BP: full-colour

BP Texture: full-colour

MOQ 250 units.

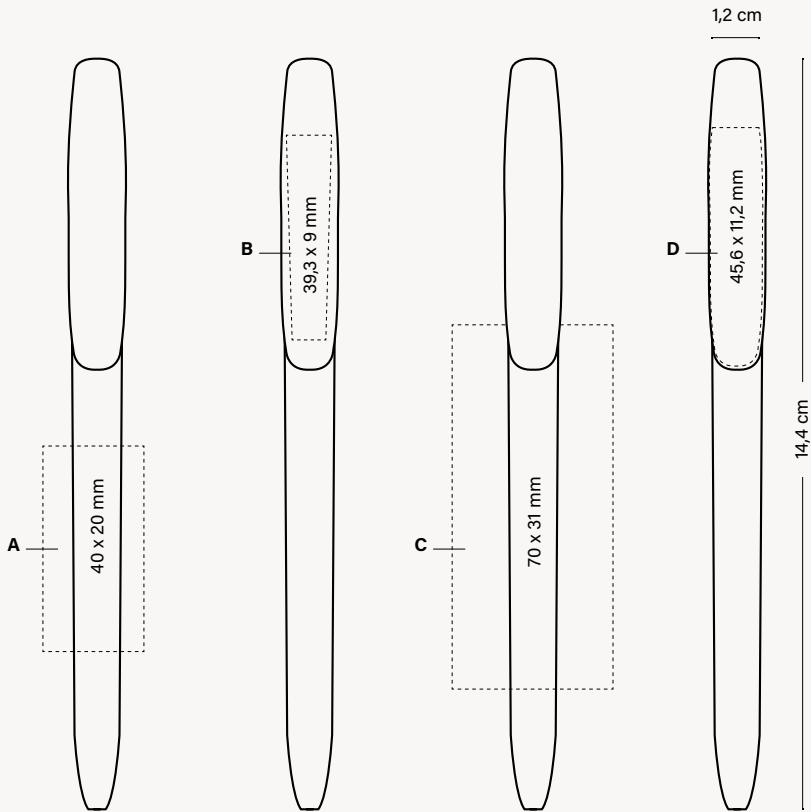

OPTIONAL SPECIAL PACKAGING



+ INFO PAGES 254 TO 265

Can be used as bookmark

EXTERNAL PACKAGING



250 ± 2,6 KG

(1, 2 & 3 units)



PERSONALISED COLOURS



MANUFACTURED AND PRINTED IN BIC FACTORIES



MADE IN SPAIN



REGULATORY COMPLIANCE



ISO certified

WRITING MODES



BALLPEN M 0.1 MM

PRINTING TECHNIQUES



SCREEN PRINTING



DIGITAL



BRITEPIX™
BRITEPIX™ TEXTURE
BRITEPIX™ PERSONALISATION

SUSTAINABILITY



IMPRIM'VERT®



ecolutions®



PLASTIC CAR PARTS



100% ELECTRICITY COMING FROM RENEWABLE SOURCES

BIC GRAPHIC

BIC® WRITING INSTRUMENTS

OTHER WRITING INSTRUMENTS

NOTEBOOKS

BIC® / DIEEP® LIGHTERS AND BIC® CASES

BIC® PACKAGING

GENERAL INFORMATION

See pages 272-276 for a detailed explanation of the icons.

1073

BIC® SUPER CLIP ADVANCE
1073 Opaque

Ink Colour
● ●



BIC® SUPER CLIP ADVANCE



Available on white barrel



MIX & MATCH

PERSONALISED COLOURS

MANUFACTURED AND PRINTED IN BIC FACTORIES

MADE IN SPAIN

REGULATORY COMPLIANCE

ISO certified

WRITING MODES

BALLPEN M
Ø 1 MM

PRINTING TECHNIQUES

SCREEN PRINTING

DIGITAL

BRITEPIX™
BRITEPIX™ TEXTURE
BRITEPIX™ PERSONALISATION

SUSTAINABILITY

IMPRIM'VERT®

100% ELECTRICITY
COMING FROM
RENEWABLE SOURCES

BIC
GRAPHIC

BIC®
WRITING INSTRUMENTS

OTHER WRITING
INSTRUMENTS

NOTEBOOKS

BIC® / DIIPEE® LIGHTERS
AND BIC® CASES

BIC®
PACKAGING

GENERAL
INFORMATION

See pages 272-276 for a detailed explanation of the icons.

BIC® SUPER CLIP ADVANCE

1073

BIC® SUPER CLIP ADVANCE
1073 Opaque

MOQ 250 units
Standard colours combination

MIX & MATCH No extra charge

Clip



Opaque

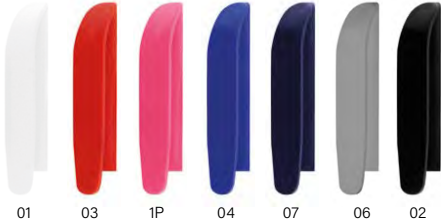

Barrel



Opaque

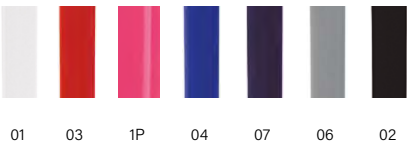

Section



ADVANCE



Exact colour match: $\geq 10,000$ units



BIC® SUPER CLIP ADVANCE

1073

BIC® SUPER CLIP ADVANCE

1073

- A SP: max. 2 col.
- B SP: max. 1 col.
- C DG: full-colour
- D BP: full-colour
- BP Texture: full-colour

MOQ 250 units.

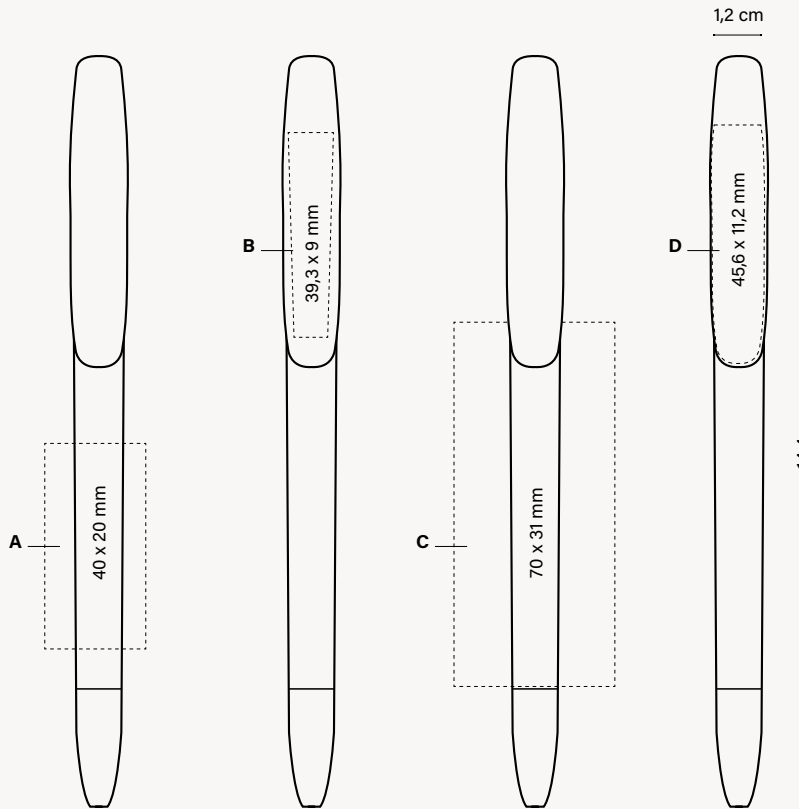

OPTIONAL SPECIAL PACKAGING



ECO SLEEVE



PLASTIC POUCH



WINDOW BOX



BIC® COLLECTION BOX

+ INFO PAGES 254 TO 265

Can be used as bookmark

(1, 2 & 3 units)

EXTERNAL PACKAGING



250 ± 2,6 KG



PERSONALISED COLOURS



MANUFACTURED AND PRINTED IN BIC FACTORIES



MADE IN SPAIN



REGULATORY COMPLIANCE



WRITING MODES



BALLPEN M Ø 1 MM

PRINTING TECHNIQUES



SCREEN PRINTING



DIGITAL



BRITEPIX™

BRITEPIX™ TEXTURE
BRITEPIX™ PERSONALISATION

SUSTAINABILITY



100% ELECTRICITY COMING FROM RENEWABLE SOURCES

BIC GRAPHIC

BIC® WRITING INSTRUMENTS

OTHER WRITING INSTRUMENTS

NOTEBOOKS

BIC® / JEEP® LIGHTERS AND BIC® CASES

BIC® PACKAGING

GENERAL INFORMATION

See pages 272-276 for a detailed explanation of the icons.

BIC® SUPER CLIP GLACÉ

Discover the BIC® Super Clip in a glamorous version.

1082

BIC® SUPER CLIP GLACÉ
1082

Ink Colour
● ●



47G

76

14G

03G

04G

05G

1:1 scale

1084

BIC® SUPER CLIP GLACÉ ADVANCE
1084

Ink Colour
● ●



47G/35

05G/35

14G/35

03G/35

04G/35

76/35

1:1 scale

Refill service on request

FR /
Découvrez le
BIC® Super Clip
dans sa version
glamour.

DE /
Entdecken Sie den
BIC® Super Clip in
der glamourösen
Version.

IT /
Scopri la
BIC® Super Clip
nella sua versione più
glamour.

ES /
Descubre el
BIC® Super Clip en
su versión
más glamurosa.

Section

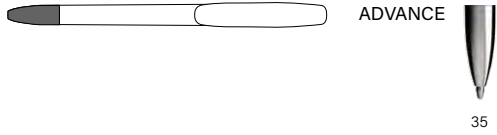

1082 / 1084

BIC® SUPER CLIP GLACÉ
1082

BIC® SUPER CLIP GLACÉ
ADVANCE
1084

A SP: max. 1 col.
B SP: max. 1 col.

MOQ 250 units
Standard colours combination

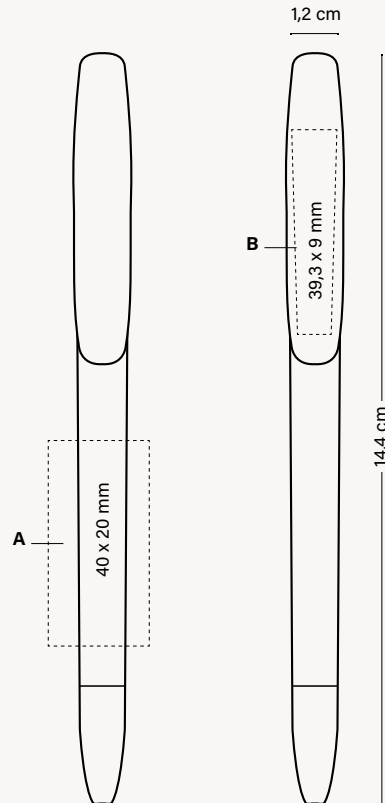

OPTIONAL SPECIAL PACKAGING



+ INFO PAGES 254 TO 265

*Can be used
as bookmark*

(1, 2 & 3 units)

EXTERNAL PACKAGING



PERSONALISED
COLOURS



MANUFACTURED
AND PRINTED IN
BIC FACTORIES



MADE
IN SPAIN



REGULATORY
COMPLIANCE



ISO
certified

WRITING
MODES



BALLPEN M
0.1 MM

PRINTING
TECHNIQUES



SCREEN PRINTING

SUSTAINABILITY



IMPRIM'VERT®



100% ELECTRICITY
COMING FROM
RENEWABLE SOURCES



CHECK OUT THE VIDEO

BIC
GRAPHIC

BIC®
WRITING INSTRUMENTS

OTHER WRITING
INSTRUMENTS

NOTEBOOKS

BIC® / DIEEP® LIGHTERS
AND BIC® CASES

BIC®
PACKAGING

GENERAL
INFORMATION

See pages 272-276 for a detailed explanation of the icons.

BIC® SUPER CLIP SOFT & ADVANCE

Feel the incredible softness of our BIC® Super Clip.



1083

BIC® SUPER CLIP SOFT
1083

Ink Colour



1:1 scale



02F



03F

07F

1085

BIC® SUPER CLIP SOFT
ADVANCE
1085

Ink Colour



1:1 scale



02F/35



03F/35

07F/35



Refill
service on
request



FR /
Découvrez
l'incroyable toucher
soyeux de notre
BIC® Super Clip.

DE /
Sie werden den
unglaublichen
Seidentouch unseres
BIC® Super Clip zu
schätzen wissen.

IT /
Apprezza l'incredibile
sensazione di setosità
della BIC® Super Clip.

ES /
Aprecia el increíble
tacto de seda de
nuestro BIC® Super Clip.

Section

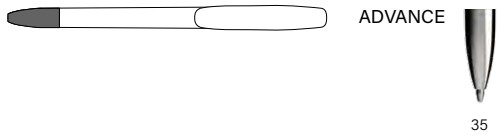

1083 / 1085

BIC® SUPER CLIP SOFT
1083

**BIC® SUPER CLIP SOFT
ADVANCE**
1085

A SP: max. 1 col.

MOQ 250 units
Standard colours combination

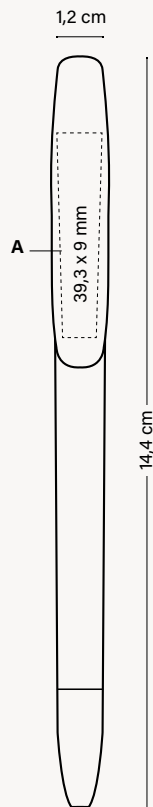

OPTIONAL SPECIAL PACKAGING



+ INFO PAGES 254 TO 265

*Can be used
as bookmark*

(1, 2 & 3 units)

EXTERNAL PACKAGING



250 ± 2,6 KG



**WRITING
MODES**



**PRINTING
TECHNIQUES**



SUSTAINABILITY



BIC
GRAPHIC

BIC®
WRITING INSTRUMENTS

OTHER WRITING
INSTRUMENTS

NOTEBOOKS

BIC® / DIBEE® LIGHTERS
AND BIC® CASES

BIC®
PACKAGING

GENERAL
INFORMATION

See pages 272-276 for a detailed explanation of the icons.

BIC® SUPER CLIP ORIGIN

BIC® Super Clip Origin is made from natural ingredients*.

ORIGIN BIOBASED

FR/

Le BIC® Super Clip Origin est fabriqué à partir de matériaux biosourcés composés de polymères naturels, à l'exclusion d'éléments provenant du pétrole et de combustibles fossiles*.

Fabriqué avec de l'huile de ricin et d'autres ingrédients d'origine végétale.*

Fabriqué et imprimé dans des usines alimentées avec **100% d'électricité d'énergie renouvelable.**

***Corps et clip 100 % biosourcés.**

DE /

BIC® Super Clip Origin besteht aus biobasiertem Material, das mit natürlichen Polymeren und ohne Erdöl oder fossile Brennstoffe hergestellt wird*.

Hergestellt mit **Rilsanöl** und anderen Materialien pflanzlichen Ursprungs.*

Hergestellt und bedruckt in Fabriken, die zu **100 % mit Strom aus erneuerbaren Quellen** betrieben werden.

***Schaft und Clip sind zu 100 % biologischen Ursprungs.**

IT /

BIC® Super Clip Origin è realizzata in materiale biobased prodotto con ingredienti naturali, nessuno dei quali deriva da petrolio o combustibili fossili*.

Realizzata con olio di ricino e altri ingredienti di origine vegetale.*

Prodotto e stampato in stabilimenti alimentati al **100% da energia elettrica rinnovabile.**

***Il fusto e la clip sono al 100% di origine biologica.**

ES/

BIC® Super Clip Origin está hecho de material biológico fabricado con polímeros naturales que excluyen cualquier fuente de petróleo o combustibles fósiles*.

Elaborado con aceite Rilsan y otros ingredientes de origen vegetal.*

Fabricado e impreso en fábricas alimentadas con **electricidad 100% renovable.**

***El cuerpo y el clip son 100 % de origen de material biológico.**

BIC® Super Clip Origin is made from biobased material manufactured with natural polymers excluding any source of petroleum or fossil fuels*.



Made with castor oil and other ingredients of vegetal origin.*



Manufactured and printed in factories 100% powered by **electricity produced using renewable sources.**



Barrel and clip are 100% biosourced.

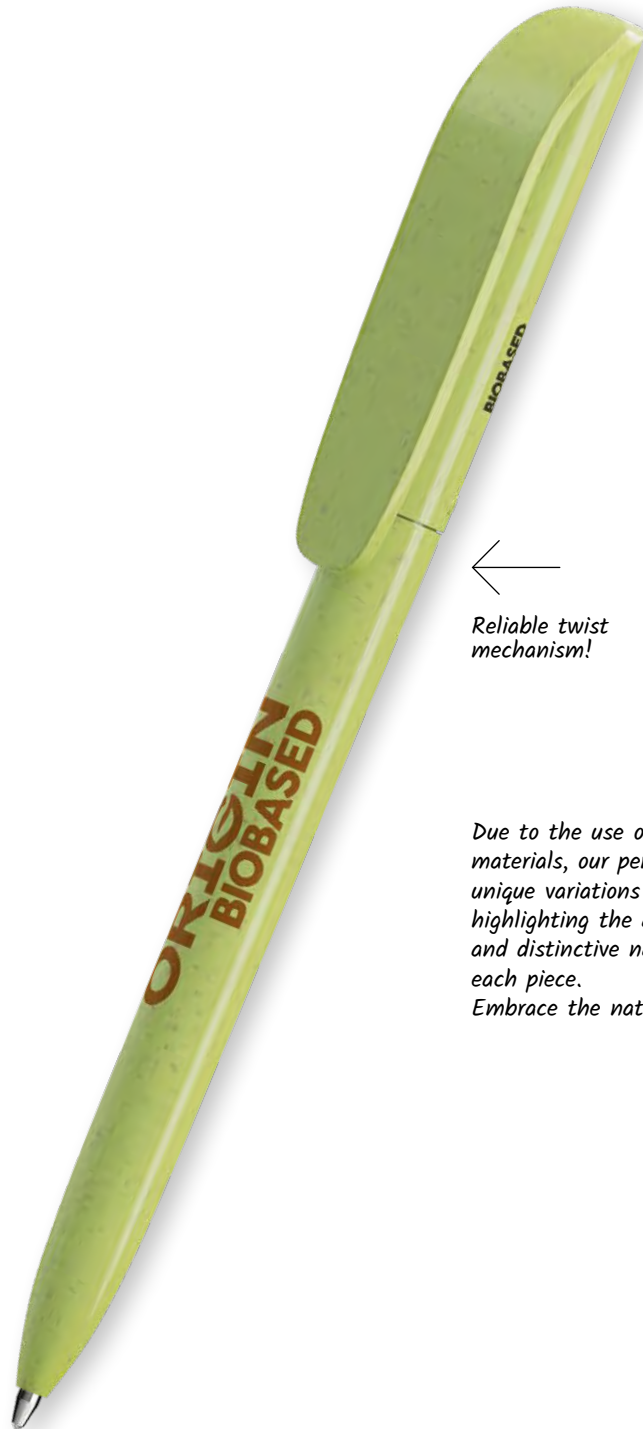

Reliable twist mechanism!

*Due to the use of natural materials, our pens feature unique variations in color, highlighting the authentic and distinctive nature of each piece.
Embrace the natural charm!*

6CO

* Refers to barrel and clip.

ORIGIN BIOBASED

1038

BIC® SUPER CLIP ORIGIN

1038 Opaque

Ink Colour



Barrel and clip are made of 100% biobased materials.

FR/ Corps et clip sont fabriqués à partir de matériaux 100 % biosourcés.

DE/ Schaft und Clip bestehen zu 100 % aus biobasierten Materialien.

IT/ Il fusto e la clip sono realizzati con materiali biologici al 100 %.

ES/ El cuerpo y el clip están fabricados con materiales 100 % biológicos.

*Due to the biobased content of the raw materials used to make the product, we cannot guarantee that the colours shown in the catalogue or colours customised to order will always have the same colour and appearance. * Refers to barrel and clip.*

BIC® SUPER CLIP ORIGIN

1038

BIC® SUPER CLIP ORIGIN

1038

A SP: max. 1 col.

MOQ 250 units
Standard colours combination

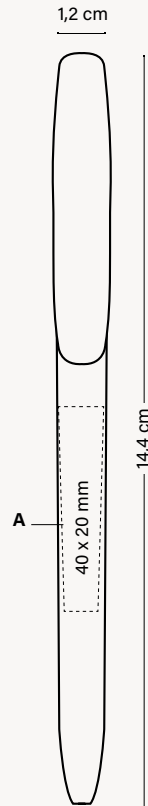

OPTIONAL SPECIAL PACKAGING



+ INFO PAGES 254 TO 265

Can be used as bookmark

(1, 2 & 3 units)

EXTERNAL PACKAGING



250 ± 2,6 KG



MANUFACTURED AND PRINTED IN BIC FACTORIES



MADE IN SPAIN



REGULATORY COMPLIANCE



WRITING MODES



BALLPEN M
Ø 1 MM

PRINTING TECHNIQUES



SCREEN PRINTING

SUSTAINABILITY



ORIGIN
BIOBASED



100% ELECTRICITY COMING FROM RENEWABLE SOURCES



CHECK OUT THE VIDEO

See pages 272-276 for a detailed explanation of the icons.

BIC GRAPHIC

BIC® WRITING INSTRUMENTS

OTHER WRITING INSTRUMENTS

NOTEBOOKS

BIC® / DIIPEE® LIGHTERS AND BIC® CASES

BIC® PACKAGING

GENERAL INFORMATION

BIC® WIDE BODY™

The right size to show the true value of your brand!

Wide profile and wide variety of possibilities to maximise your message.

FR /

La taille idéale pour mettre en valeur votre marque !

Corps large et multiples possibilités pour optimiser votre communication.

DE /

Die richtige Größe, um den Wert Ihrer Marke widerzuspiegeln!

Breites Profil und eine Vielzahl von Möglichkeiten, Ihre Botschaft klar zu vermitteln.

IT /

La giusta misura per mostrare il vero valore del tuo marchio!

Ampio profilo e vasta gamma di possibilità per ottimizzare il tuo messaggio.

ES /

¡El tamaño ideal para enseñar el valor real de tu marca!

De perfil ancho y gran variedad de posibilidades para maximizar tu mensaje.

Perfect for your big ideas

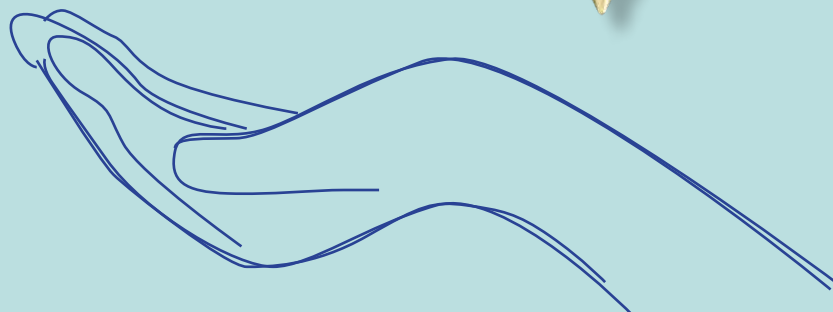

1080

BIC® WIDE BODY™
1080 Opaque

Ink Colour
● ● ●

Red Ink available under request

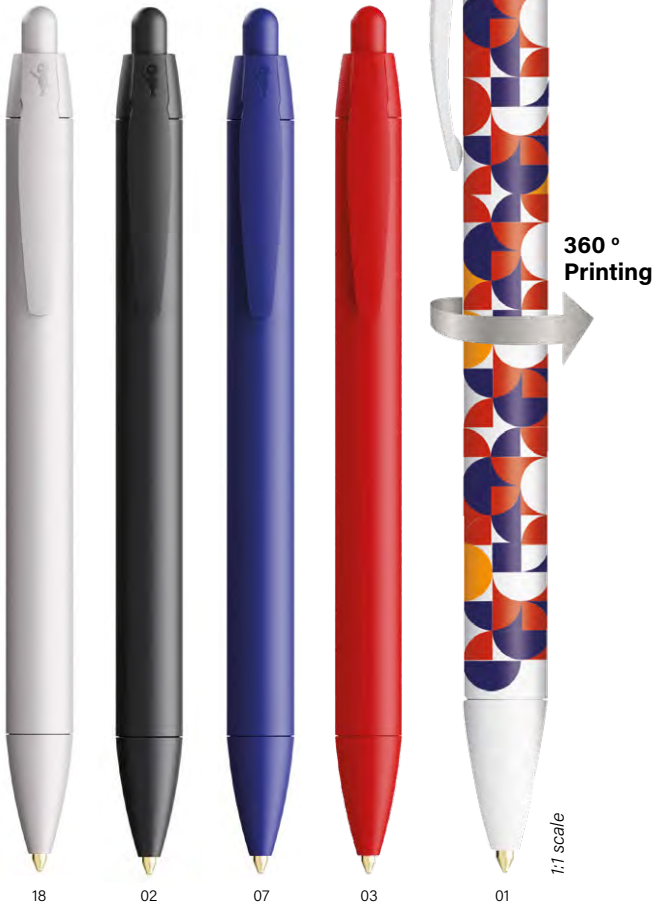

Available on
white barrel



Iconic BIC® Boy
is embossed

ECO version and
standard at the same price!

ecolutions®



MADE FROM **98%**
RECYCLED MATERIAL*
*From barrel



FRUIT AND
VEGETABLE TRAYS

1E80

BIC® WIDE BODY™
ecolutions® 1E80 Opaque

Ink Colour
● ● ●

Red Ink available
under request

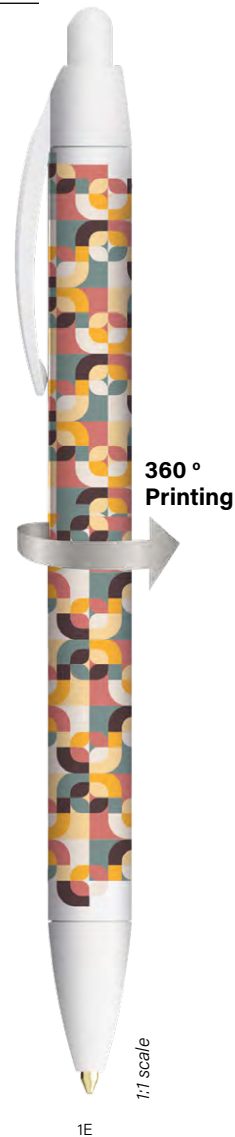

Available on
white barrel



**MIX&
MATCH**



PERSONALISED
COLOURS



MANUFACTURED
AND PRINTED IN
BIC FACTORIES



MADE IN SPAIN



REGULATORY
COMPLIANCE



ISO
certified

**WRITING
MODES**



BALLPEN M
Ø 1 MM

**PRINTING
TECHNIQUES**



SCREEN PRINTING



DIGITAL

SUSTAINABILITY



IMPRIM'VERT®

ecolutions®



FRUIT AND
VEGETABLE TRAYS



100% ELECTRICITY
COMING FROM
RENEWABLE SOURCES

BIC
GRAPHIC

BIC®
WRITING INSTRUMENTS

OTHER WRITING
INSTRUMENTS

NOTEBOOKS

BIC® / DIEEP® LIGHTERS
AND BIC® CASES

BIC®
PACKAGING

GENERAL
INFORMATION

See pages 272-276 for a detailed explanation of the icons.

*The percentage is calculated based on total weight of the barrel. Due to the recycled content of the raw materials used to make the product, we cannot guarantee that the colours shown in the catalogue or colours customised to order will always have the same colour and appearance.

1080

BIC® WIDE BODY™
1080 Frosted

Ink Colour
● ● ●

Red Ink available under request



*Large
printing
areas!*



1893

BIC® WIDE BODY™
MINI DIGITAL
1893 Opaque

Ink Colour
● ● ●

Red Ink available under request



*Available on
white barrel*



1080 / 1E80 / 1893

MOQ 250 units
Standard colours combination

MIX & MATCH No extra charge

Plug

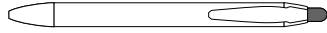

Opaque

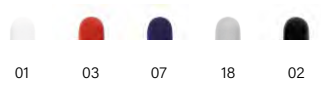

Frosted

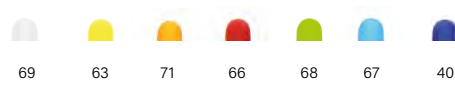

Clip

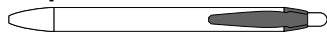

Opaque

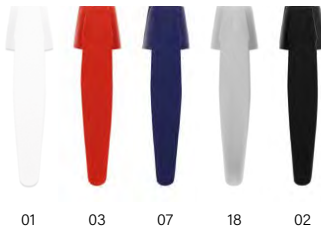

Frosted

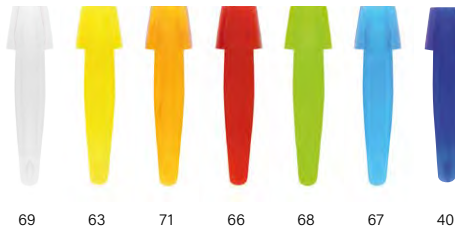

Barrel



Opaque

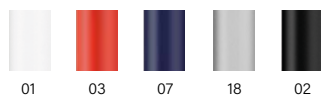

Frosted

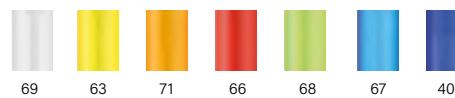

Opaque



ecolutions®*



Add the Möbius loop to your artwork at no additional charge. Please specify "Print the Möbius loop" on your order. (Möbius loop imprint defaults to left-hand corner.)

*From barrel



FRUIT AND VEGETABLE TRAYS

Section



Opaque

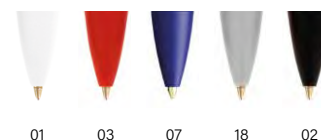

Frosted



Exact colour match: ≥ 10.000 units



MIX & MATCH



PERSONALISED COLOURS



MANUFACTURED AND PRINTED IN BIC FACTORIES



MADE IN SPAIN



REGULATORY COMPLIANCE



WRITING MODES



BALLPEN M Ø 1 MM

PRINTING TECHNIQUES



SCREEN PRINTING



DIGITAL

SUSTAINABILITY



ecolutions®



100% ELECTRICITY COMING FROM RENEWABLE SOURCES



FRUIT AND VEGETABLE TRAYS

*Due to the recycled content of the raw materials used to make the product, we cannot guarantee that the colours shown in the catalogue or colours customised to order will always have the same colour and appearance.

1080 / 1E80

BIC® WIDE BODY™

1080 Opaque

eColutions® 1E80

A/C SP: max. 2 col.

B/E SP: max. 1 col.

D DG: full-colour

MOQ 250 units (SP)

MOQ 500 units (DG)

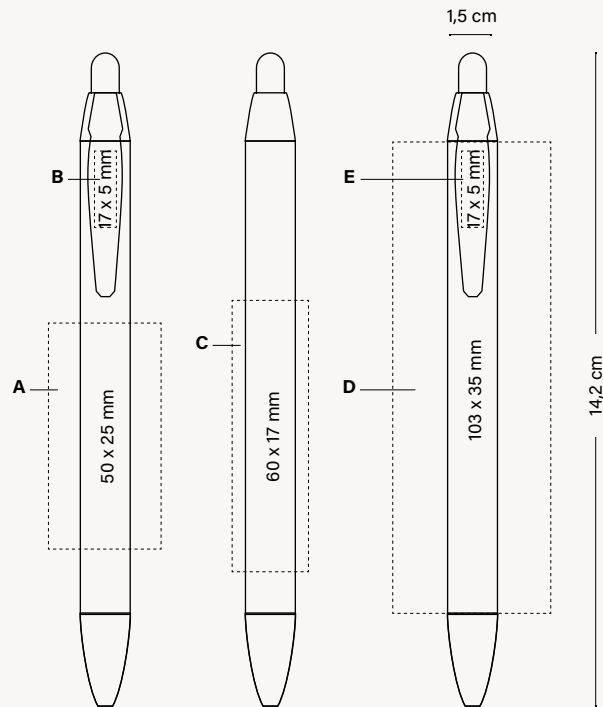

OPTIONAL SPECIAL PACKAGING



ECO SLEEVE



PLASTIC POUCH



WINDOW BOX



BIC® COLLECTION BOX

+ INFO PAGES 254 TO 265

Can be used as bookmark

(1, 2 & 3 units)

EXTERNAL PACKAGING



250 ± 2,6KG

1893

**BIC® WIDE BODY™
MINI DIGITAL**

1893

A DG: full-colour

MOQ 500 units (DG)

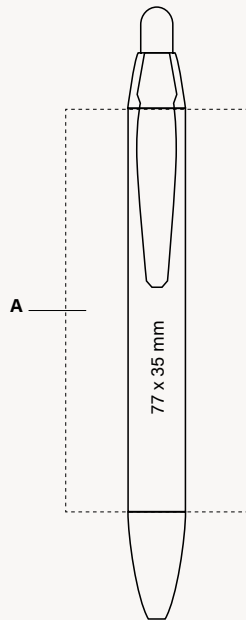

OPTIONAL SPECIAL PACKAGING



+ INFO PAGES 254 TO 265

*Can be used
as bookmark*

(1, 2 & 3 units)

EXTERNAL PACKAGING



500 ± 3,68KG

**MIX &
MATCH**



PERSONALISED
COLOURS



MANUFACTURED
AND PRINTED IN
BIC FACTORIES



MADE IN SPAIN



REGULATORY
COMPLIANCE



**WRITING
MODES**



BALLPEN M
Ø 1 MM

**PRINTING
TECHNIQUES**



SCREEN PRINTING



DIGITAL

SUSTAINABILITY



ecolutions®



100% ELECTRICITY
COMING FROM
RENEWABLE SOURCES



FRUIT AND
VEGETABLE TRAYS

BIC® 4 COLOURS®

The world-renowned BIC® 4 Colours® ballpen gives you the convenience of four different ink colours in one ballpoint pen.

FR/
Le stylo à bille de renommée mondiale le BIC® 4 Couleurs® vous offre la commodité de quatre couleurs d'encre différentes dans un seul stylo à bille.

DE/
Der weltbekannte BIC® 4 Colours® Kugelschreiber bietet Ihnen die Verwendung von vier verschiedenen Tintenfarben in einem Stift.

IT/
BIC® 4 Colours® ti offre la comodità di quattro diversi colori di inchiostro in un'unica penna.

ES/
¿A qué esperas para empezar tu colección? El mundialmente reconocido bolígrafo BIC® 4 Colours® te ofrece la comodidad de cuatro colores de tinta diferentes en el mismo bolígrafo.



1101 BIC® 4 Colours® with lanyard



1100 BIC® 4 Colours®



1100 BIC® 4 Colours® Metallic Foil

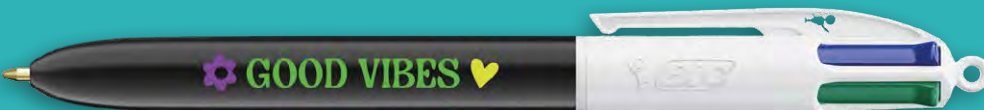

1133 BIC® 4 Colours® ECO
1134 with lanyard



1123 BIC® 4 Colours® Rainbow Decor
1124 with lanyard



1069 BIC® 4 Colours® Bicolor
1076 with lanyard



1074 BIC® 4 Colours® Gradient
1075 with lanyard



1071 BIC® 4 Colours® Pastel
1072 with lanyard



1102 BIC® 4 Colours® Fashion
1108 with lanyard



1097 BIC® 4 Colours® Sun
1098 with lanyard



1109 BIC® 4 Colours® Fine
1111 with lanyard



1114 BIC® 4 Colours® Fluo
1116 with lanyard



1057 BIC® 4 Colours® Glacé
1058 with lanyard



1106 BIC® 4 Colours® Shine
1107 with lanyard



1060 BIC® 4 Colours® Soft
1063 with lanyard



1061 BIC® 4 Colours® Wood Style
1064 with lanyard



1067 BIC® 4 Colours®
Flags Collection
1068 with lanyard



1099 BIC® 4 Colours® 3+1^{HB}

BIC®
GRAPHIC

BIC®
WRITING INSTRUMENTS

OTHER WRITING
INSTRUMENTS

NOTEBOOKS

BIC® / DIEEP® LIGHTERS
AND BIC® CASES

BIC®
PACKAGING

GENERAL
INFORMATION

BIC® 4 COLOURS®

collection 

Always an icon.

Since
1970!



THE SOLUTION
FOR FULL COLOUR
COMMUNICATION!

1100 / 1101

BIC® 4 COLOURS®

1100 Opaque

1101 With lanyard

Ink Colour



360°
Printing

NEW!

Metallic Foil



Refill
service on
request

1:1 scale

FR /
Toujours une icône.

DE /
Immer ein Kultmodell.

IT /
Sempre un'icona.

ES /
Siempre un icono.

1100 / 1101

BIC® 4 COLOURS®
1100/1101

- A SP:** max. 4 col.
- B DG/MF:** Digital print (area for images)
- C BP:** full-colour
- D SP:** 1 col. (only for white upper parts)

MOQ 250 units (SP, DG)
MOQ 100 units (BP)

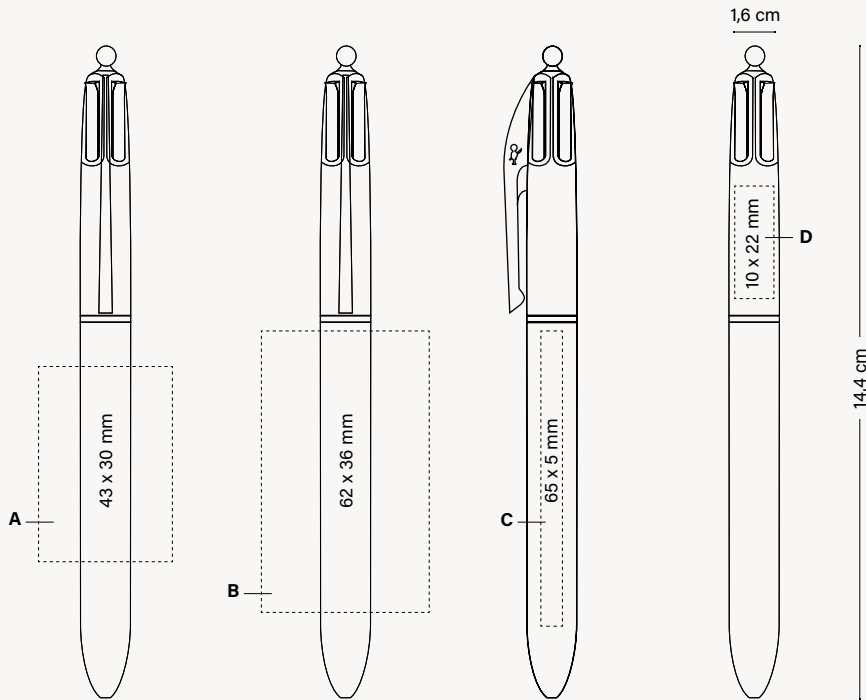

OPTIONAL SPECIAL PACKAGING



+ INFO PAGES 254 TO 265

Can be used as bookmark

(1, 2 & 3 units)

EXTERNAL PACKAGING



WRITING MODES



PRINTING TECHNIQUES



SUSTAINABILITY



See pages 272-276 for a detailed explanation of the icons.

New barrel made from 98% recycled plastic coming from car parts*.

1133 / 1134

BIC® 4 COLOURS® ECO

1133 Opaque

1134 With lanyard

Ink Colour



NEW!



01/1E



02/3E

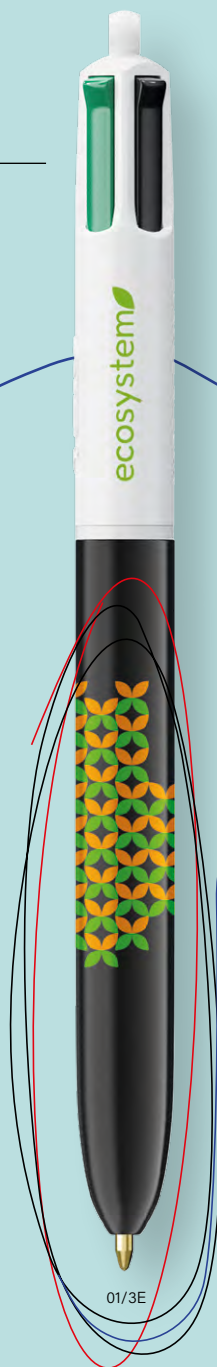

01/3E

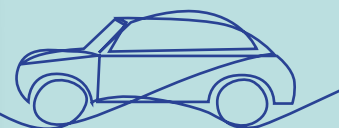

Barrel



Refill service on request

1:1 scale

FR / **Nouveau corps fabriqué à partir de 98 % de plastique recyclé provenant de pièces automobiles*.**

DE / **Neuer Schaft hergestellt aus 98 % recyceltem Kunststoff aus Autoteilen*.**

IT / **Nuovo fusto realizzato con il 98% di plastica riciclata proveniente da parti di automobili*.**

ES / **Nuevo cuerpo fabricado con un 98 % de plástico reciclado procedente de piezas de automóviles*.**

BIC® 4 COLOURS® ECO

1133 / 1134

BIC® 4 COLOURS® ECO

1133/1134

A SP: max. 3 col.

B SP: 1 col. (only for white upper parts)

MOQ 250 units

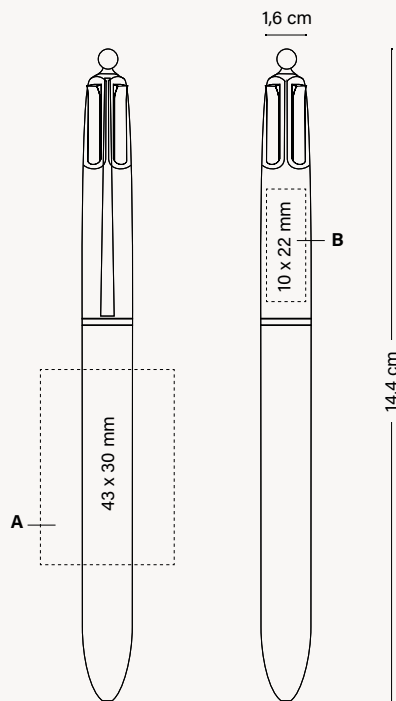

OPTIONAL SPECIAL PACKAGING



+ INFO PAGES 254 TO 265

Can be used as bookmark

(1, 2 & 3 units)

EXTERNAL PACKAGING



BIC® GRAPHIC

BIC® WRITING INSTRUMENTS

OTHER WRITING INSTRUMENTS

NOTEBOOKS

BIC® / DIEEP® LIGHTERS AND BIC® CASES

BIC® PACKAGING

GENERAL INFORMATION

* The percentage is calculated based on total weight of the barrel. Due to the recycled content of the raw materials used to make the product, we cannot guarantee that the colours shown in the catalogue or colours customised to order will always have the same colour and appearance.

Colour Your World!

Your Life, Your Style.

1123 / 1124

BIC® 4 COLOURS® RAINBOW DECOR

1123

1124 With Lanyard

Ink Colour



Refill
service on
request

1:1 scale

01/9Y

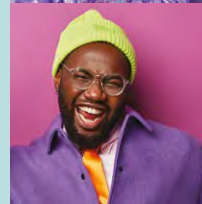
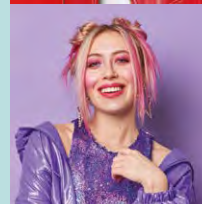
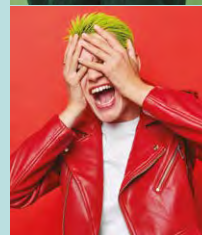
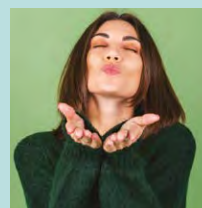

FR /

Colorez votre monde !

Votre vie, votre style.

DE /

Bringe Farbe in deine Welt!

Dein Leben, dein Stil.

IT /

Colora il tuo mondo!

La tua vita, il tuo stile.

ES /

¡Colorea tu mundo!

Tu vida, tu estilo.

BIC® 4 COLOURS® RAINBOW DECOR

1123 / 1124

BIC® 4 COLOURS® RAINBOW DECOR
1123/1124

A SP: max. 2 col.
B SP: max. 1 col.

MOQ 250 units (SP)

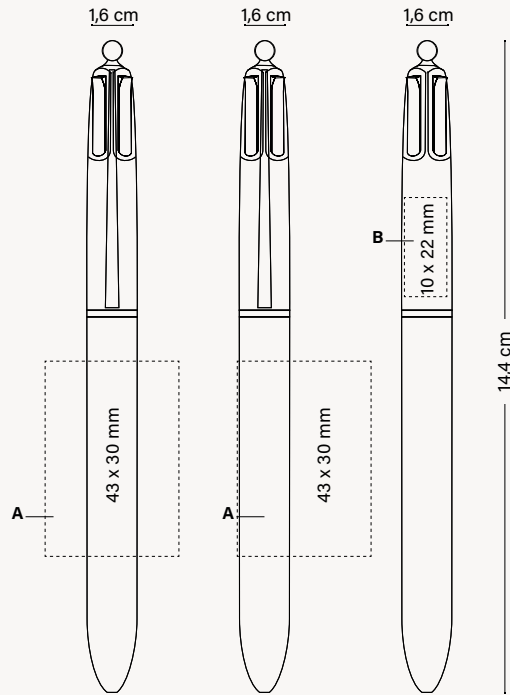

OPTIONAL SPECIAL PACKAGING



+ INFO PAGES 254 TO 265



*Can be used
as bookmark*



(1, 2 & 3 units)

EXTERNAL PACKAGING



250 ± 3,2KG



PERSONALISED
COLOURS



MANUFACTURED
AND PRINTED IN
BIC FACTORIES



MADE IN FRANCE



REGULATORY
COMPLIANCE



ISO
certified

WRITING
MODES



BALLPEN M
Ø 1 MM

PRINTING
TECHNIQUES



SCREEN PRINTING

SUSTAINABILITY



IMPRIM'VERT®



100% ELECTRICITY
COMING FROM
RENEWABLE SOURCES



CHECK OUT THE VIDEO

See pages 272-276 for a detailed explanation of the icons.

BIC
GRAPHIC

BIC®
WRITING INSTRUMENTS

OTHER WRITING
INSTRUMENTS

NOTEBOOKS

BIC® / DEEPP® LIGHTERS
AND BIC® CASES

BIC®
PACKAGING

GENERAL
INFORMATION

Metallic aesthetics with an artistic touch.



1069 / 1076

BIC® 4 COLOURS® BICOLOR

1069

1076 With Lanyard

Ink Colour



01/04G/47



01/05G/47



01/80/47



01/4R/47



Refill service on request

1:1 scale

FR /

Une esthétique métallique avec une touche artistique.

DE /

Ein Metallic-Look mit künstlerischer Note.

IT /

Look metallico con un tocco artistico.

ES /

Estética metálica con un toque artístico.

BIC® 4 COLOURS® BICOLOR

1069 / 1076

BIC® 4 COLOURS® BICOLOR®
1069/1076

A SP: max. 2 col.
B SP: max. 1 col.

MOQ 250 units

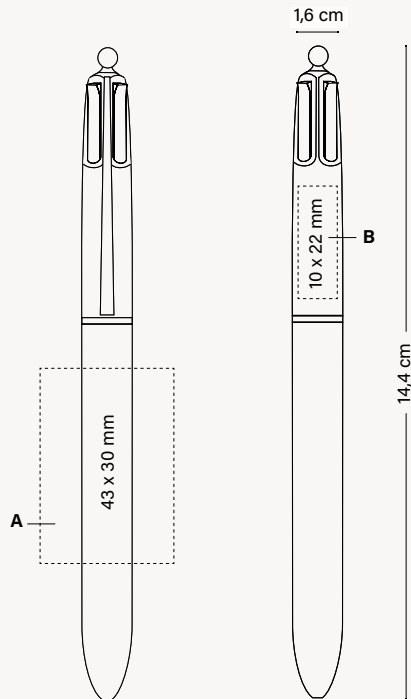

OPTIONAL SPECIAL PACKAGING



EXTERNAL PACKAGING



PERSONALISED
COLOURS



MANUFACTURED
AND PRINTED IN
BIC FACTORIES



FABRIQUÉ
EN FRANCE
MADE IN FRANCE



REGULATORY
COMPLIANCE



ISO
certified

WRITING
MODES



BALLPEN M
Ø 1 MM

PRINTING
TECHNIQUES



SCREEN PRINTING

SUSTAINABILITY



IMPRIM'VERT®



100% ELECTRICITY
COMING FROM
RENEWABLE SOURCES



CHECK OUT THE VIDEO

See pages 272-276 for a detailed explanation of the icons.

BIC
GRAPHIC

BIC®
WRITING INSTRUMENTS

OTHER WRITING
INSTRUMENTS

NOTEBOOKS

BIC® / DIEEP® LIGHTERS
AND BIC® CASES

BIC®
PACKAGING

GENERAL
INFORMATION

The most summery vibes.

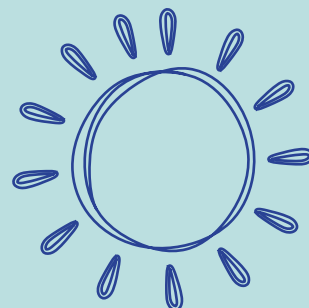

1074 / 1075

BIC® 4 COLOURS® GRADIENT

1074

1075 With Lanyard

Ink Colour



Refill
service on
request

1:1 scale

01/3G/8D/4R

FR /
**Un look
total d'été.**

DE /
**Die beste
Sommer-Stimmung.**

IT /
**Un'esplosione di
colori estivi.**

ES /
**Las vibraciones
más veraniegas.**

BIC® 4 COLOURS® GRADIENT

1074 / 1075

BIC® 4 COLOURS® GRADIENT

1074/1075

A SP: max. 2 col.

B SP: max. 1 col.

MOQ 250 units

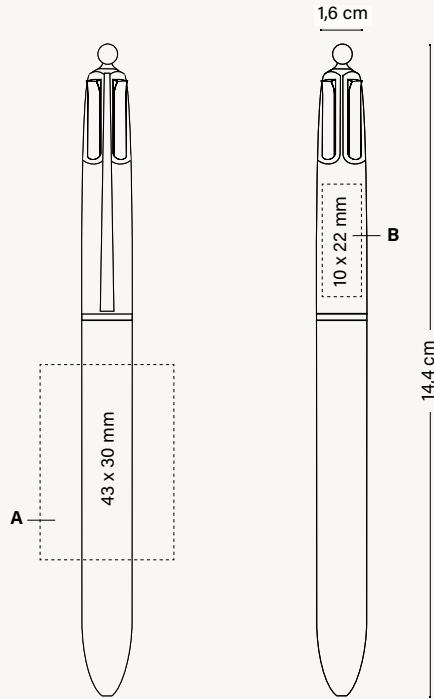

OPTIONAL SPECIAL PACKAGING



ECO SLEEVE



PLASTIC POUCH



WINDOW BOX



BIC® COLLECTION BOX



250 ± 3,2KG

+ INFO PAGES 254 TO 265

Can be used as bookmark

(1, 2 & 3 units)

EXTERNAL PACKAGING



PERSONALISED COLOURS



MANUFACTURED AND PRINTED IN BIC FACTORIES



MADE IN FRANCE



REGULATORY COMPLIANCE



ISO certified

WRITING MODES



BALLPEN M
Ø 1 MM

PRINTING TECHNIQUES



SCREEN PRINTING

SUSTAINABILITY



IMPRIM'VERT®



100% ELECTRICITY COMING FROM RENEWABLE SOURCES



CHECK OUT THE VIDEO

See pages 272-276 for a detailed explanation of the icons.

GENERAL INFORMATION

BIC® PACKAGING

BIC® / DIEEP® LIGHTERS AND BIC® CASES

NOTEBOOKS

OTHER WRITING INSTRUMENTS

BIC® WRITING INSTRUMENTS

BIC GRAPHIC

Vintage colours, dreamy imagery.

1071 / 1072

BIC® 4 COLOURS® PASTEL

1071 Opaque

1072 With Lanyard

Ink Colour



Refill
service on
request

1:1 scale

FR /
**Des couleurs
vintages,
tout un rêve.**

DE /
**Vintage-Farben,
eine verträumte
Bildsprache.**

IT /
**Colori vintage,
immagini da
sogno.**

ES /
**Colores
vintage
de ensueño.**

BIC® 4 COLOURS® PASTEL

1071 / 1072

BIC® 4 COLOURS® PASTEL

1071/1072

A SP: max. 4 col.
B DG: Digital print

MOQ 250 units

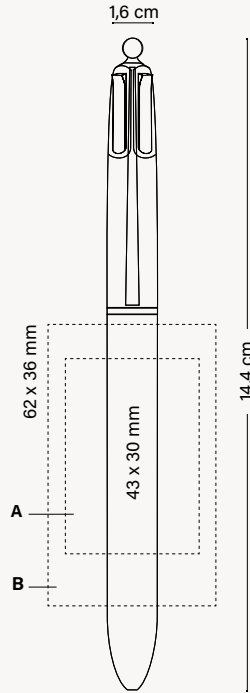

OPTIONAL SPECIAL PACKAGING



ECO SLEEVE

+ INFO PAGES 254 TO 265



PLASTIC POUCH



WINDOW BOX



BIC® COLLECTION BOX

Can be used as bookmark

(1, 2 & 3 units)

EXTERNAL PACKAGING



250 ± 3,2KG



PERSONALISED COLOURS



MANUFACTURED AND PRINTED IN BIC FACTORIES



MADE IN FRANCE



REGULATORY COMPLIANCE



ISO certified

WRITING MODES



BALLPEN M
Ø 1 MM

PRINTING TECHNIQUES



SCREEN PRINTING



DIGITAL

SUSTAINABILITY



IMPRIM'VERT®



100% ELECTRICITY COMING FROM RENEWABLE SOURCES



CHECK OUT THE VIDEO

BIC GRAPHIC

BIC® WRITING INSTRUMENTS

OTHER WRITING INSTRUMENTS

NOTEBOOKS

BIC® / DIEEP® LIGHTERS AND BIC® CASES

BIC® PACKAGING

GENERAL INFORMATION

See pages 272-276 for a detailed explanation of the icons.

britePix
DIGITAL THE SOLUTION
FOR FULL COLOUR
COMMUNICATION!

1102 / 1108

BIC® 4 COLOURS® FASHION

1102 Opaque
1108 With Lanyard

Ink Colour
●●●●



01/01



01/84



01/24



Fashion inks!

**360°
Printing**



**Refill
service on
request**

1:1 scale

BIC® 4 COLOURS® FASHION

1102 / 1108

BIC® 4 COLOURS® FASHION
1102/1108

A SP: max. 4 col.
B DG: Digital print (area for images)
C BP: full-colour
D SP: max. 1 col.

MOQ 250 units (SP, DG)
MOQ 100 units (BP)

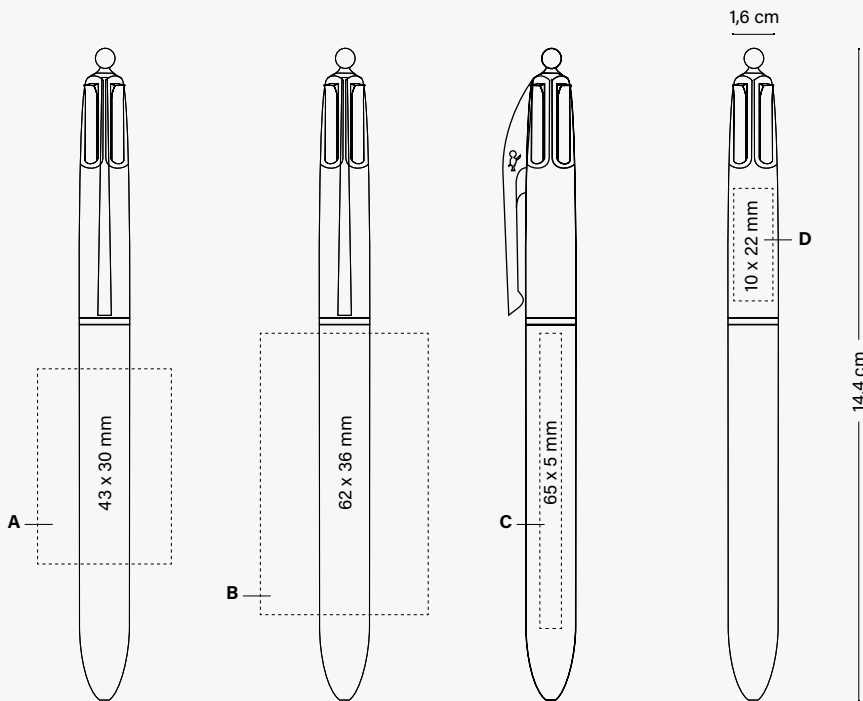

OPTIONAL SPECIAL PACKAGING



ECO SLEEVE

+ INFO PAGES 254 TO 265



PLASTIC POUCH

Can be used as bookmark



WINDOW BOX



BIC® COLLECTION BOX

(1, 2 & 3 units)

EXTERNAL PACKAGING



250 ± 3,2KG



PERSONALISED COLOURS



MANUFACTURED AND PRINTED IN BIC FACTORIES



MADE IN FRANCE



REGULATORY COMPLIANCE



ISO certified

WRITING MODES



BALLPEN M
Ø 1 MM

PRINTING TECHNIQUES



SCREEN PRINTING



BRITEPIX™
BRITEPIX™ TEXTURE
BRITEPIX™ PERSONALISATION

SUSTAINABILITY



IMPRIM'VERT®



100% ELECTRICITY COMING FROM RENEWABLE SOURCES

BIC GRAPHIC

BIC® WRITING INSTRUMENTS

OTHER WRITING INSTRUMENTS

NOTEBOOKS

BIC® / DIEEP® LIGHTERS AND BIC® CASES

BIC® PACKAGING

GENERAL INFORMATION

See pages 272-276 for a detailed explanation of the icons.

britePix DIGITAL THE SOLUTION FOR FULL COLOUR COMMUNICATION!

1097 / 1098

BIC® 4 COLOURS® SUN

1097 Opaque
1098 With Lanyard

Ink Colour



Flashy colours:
orange & yellow

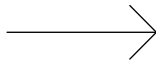

01/12

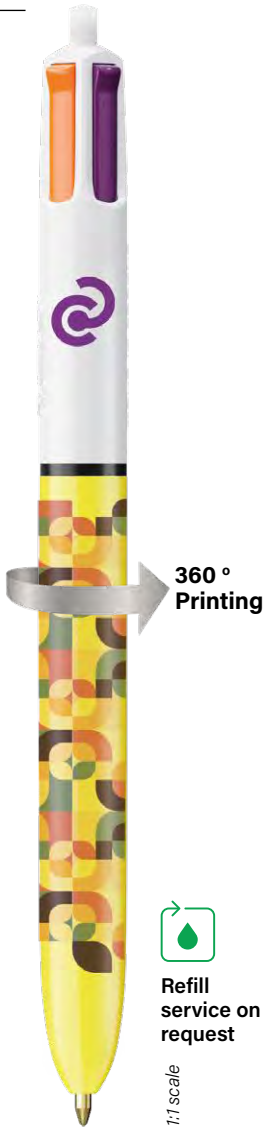

01/12

1097 / 1098

BIC® 4 COLOURS® SUN

1097/1098

A SP: max. 4 col.

B DG: Digital print (area for images)

C BP: full-colour

D SP: max. 1 col.

MOQ 250 units (SP, DG)

MOQ 100 units (BP)

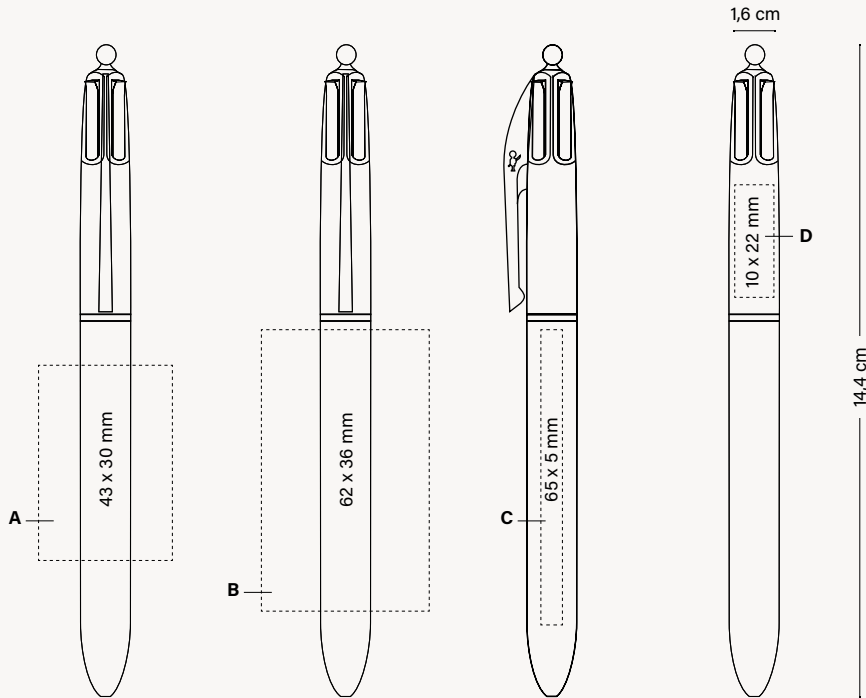

OPTIONAL SPECIAL PACKAGING



ECO SLEEVE



PLASTIC POUCH



WINDOW BOX



BIC® COLLECTION BOX

EXTERNAL PACKAGING



250 ± 3,2KG

+ INFO PAGES 254 TO 265

Can be used as bookmark

(1, 2 & 3 units)



PERSONALISED COLOURS



MANUFACTURED AND PRINTED IN BIC FACTORIES



FABRIQUÉ EN FRANCE

MADE IN FRANCE



REGULATORY COMPLIANCE



ISO certified

WRITING MODES



BALLPEN M Ø 1 MM

PRINTING TECHNIQUES



SCREEN PRINTING



DIGITAL



BRITEPIX™
BRITEPIX™ TEXTURE
BRITEPIX™ PERSONALISATION

SUSTAINABILITY



IMPRIM'VERT®



100% ELECTRICITY COMING FROM RENEWABLE SOURCES



THE SOLUTION
FOR FULL COLOUR
COMMUNICATION!

1109 / 1111

BIC® 4 COLOURS® FINE

1109 Opaque
1111 With Lanyard

Ink Colour
●●●●



01/10



360°
Printing



Refill
service on
request

1:1 scale

01/10

0.8 mm
tip!

BIC® 4 COLOURS® FINE

1109 / 1111

BIC® 4 COLOURS® FINE

1109/1111

- A SP:** max. 4 col.
- B DG:** Digital print
- C BP:** full-colour
- D SP:** max. 1 col.

MOQ 250 units (SP, DG)
MOQ 100 units (BP)

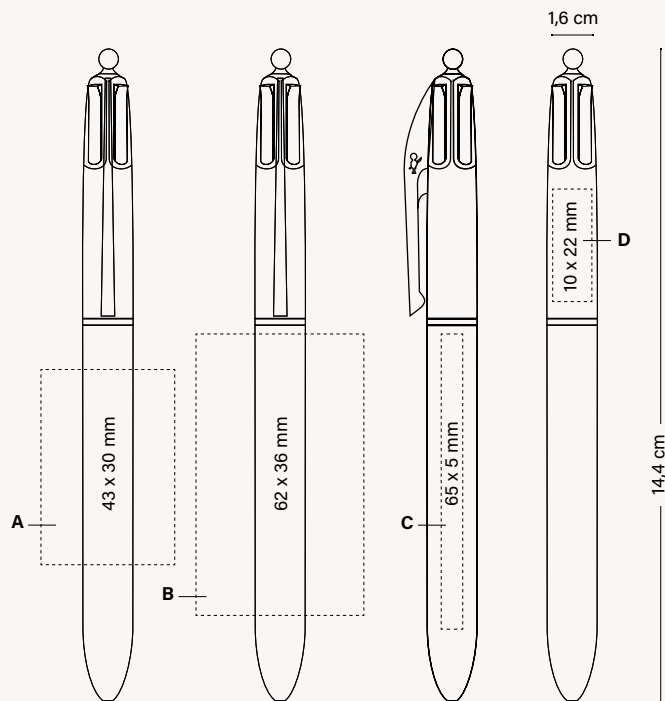

OPTIONAL SPECIAL PACKAGING



ECO SLEEVE

+ INFO PAGES 254 TO 265



PLASTIC POUCH



WINDOW BOX



BIC® COLLECTION BOX

Can be used as bookmark

(1, 2 & 3 units)

EXTERNAL PACKAGING



250 ± 3,2KG



PERSONALISED COLOURS



MANUFACTURED AND PRINTED IN BIC FACTORIES



MADE IN FRANCE



REGULATORY COMPLIANCE



ISO certified

WRITING MODES



BALLPEN M
Ø 0,8 MM

PRINTING TECHNIQUES



SCREEN PRINTING



DIGITAL



BRITEPIX™
BRITEPIX™ TEXTURE
BRITEPIX™ PERSONALISATION

SUSTAINABILITY



IMPRIM'VERT®



100% ELECTRICITY COMING FROM RENEWABLE SOURCES

BIC GRAPHIC

BIC® WRITING INSTRUMENTS

OTHER WRITING INSTRUMENTS

NOTEBOOKS

BIC® / DIEEP® LIGHTERS AND BIC® CASES

BIC® PACKAGING

GENERAL INFORMATION

See pages 272-276 for a detailed explanation of the icons.

1114 / 1116

BIC® 4 COLOURS® FLUO

1114 Opaque
1116 With Lanyard

Ink Colour



4 inks, one of them fluo!



01/4D



01/4D



Refill service on request

1:1 scale

BIC® 4 COLOURS® FLUO

1114 / 1116

BIC® 4 COLOURS® FLUO

1114/1116

A SP: max. 4 col.
B BP: full-colour
C SP: max. 1 col.

MOQ 250 units (SP)
 MOQ 100 units (BP)

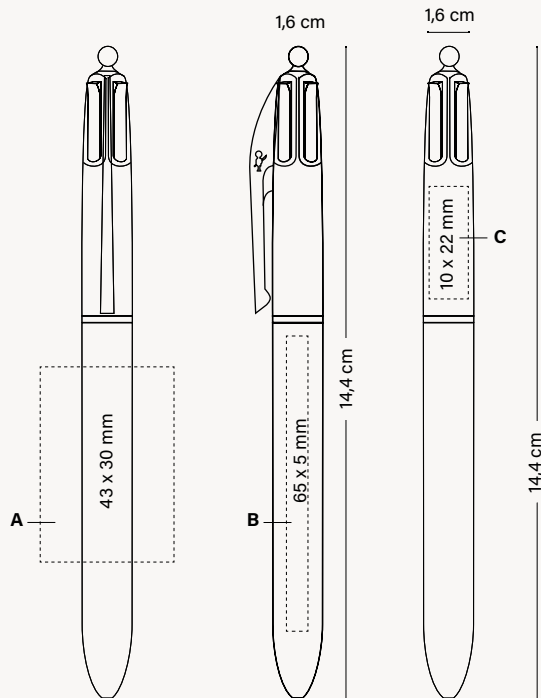

OPTIONAL SPECIAL PACKAGING



ECO SLEEVE



PLASTIC POUCH



WINDOW BOX



BIC® COLLECTION BOX

+ INFO PAGES 254 TO 265

Can be used as bookmark

(1, 2 & 3 units)

EXTERNAL PACKAGING



250 ± 3,2KG



PERSONALISED COLOURS



MANUFACTURED AND PRINTED IN BIC FACTORIES



MADE IN FRANCE



REGULATORY COMPLIANCE



ISO certified

WRITING MODES



BALLPEN M 0.1 MM

PRINTING TECHNIQUES



SCREEN PRINTING



BRITEPIX™
 BRITEPIX™ TEXTURE
 BRITEPIX™ PERSONALISATION

SUSTAINABILITY



IMPRIM'VERT®



100% ELECTRICITY COMING FROM RENEWABLE SOURCES

BIC GRAPHIC

BIC® WRITING INSTRUMENTS

OTHER WRITING INSTRUMENTS

NOTEBOOKS

BIC® / DEEPP® LIGHTERS AND BIC® CASES

BIC® PACKAGING

GENERAL INFORMATION

See pages 272-276 for a detailed explanation of the icons.

Our classic pen dressed up.

1057 / 1058

BIC® 4 COLOURS® GLACÉ

1057

1058 With Lanyard

Ink Colour

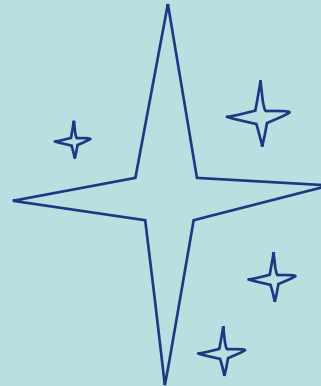

01/76



01/47G

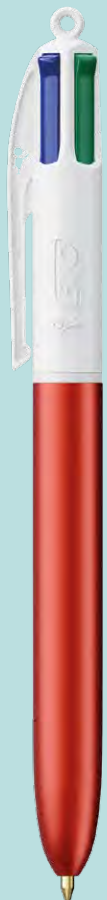

01/03G



01/05G



01/04G



02/47G



02/76



01/14G



Refill service on request

1:1 scale

FR /

Notre stylo classique dans sa plus belle tenue.

DE /

Unser klassischer Kugelschreiber kleidet sich festlich.

IT /

La nostra penna iconica in abito elegante.

ES /

Nuestro bolígrafo clásico se viste de gala.

BIC® 4 COLOURS® GLACÉ

1057 / 1058

BIC® 4 COLOURS® GLACÉ
1057/1058

A SP: max. 2 col.
B SP: max. 1 col. (only for white upper parts)

MOQ 250 units

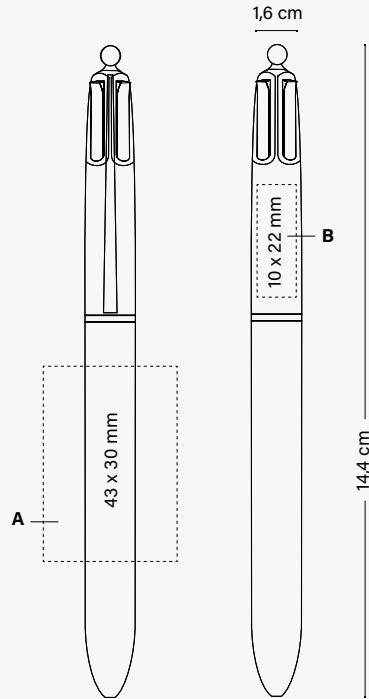

PERSONALISED
COLOURS



MANUFACTURED
AND PRINTED IN
BIC FACTORIES



FABRIQUÉ
EN FRANCE
MADE IN FRANCE



REGULATORY
COMPLIANCE



ISO
certified



WRITING
MODES



BALLPEN M
Ø 1 MM



PRINTING
TECHNIQUES



SP
SCREEN PRINTING

SUSTAINABILITY



IMPRIM'VERT®



100% ELECTRICITY
COMING FROM
RENEWABLE SOURCES

OPTIONAL SPECIAL PACKAGING

EXTERNAL PACKAGING



ECO
SLEEVE



PLASTIC
POUCH



WINDOW
BOX



BIC®
COLLECTION
BOX



250 ± 3,2KG

+ INFO PAGES 254 TO 265

Can be used
as bookmark

(1, 2 & 3 units)

See pages 272-276 for a detailed explanation of the icons.

1106 / 1107

BIC® 4 COLOURS® SHINE

1106
1107 With Lanyard

Ink Colour
● ● ● ●



01/75



01/26



01/7G



01/34



01/97

Super shiny barrels!



Refill service on request

1:1 scale

BIC® 4 COLOURS® SHINE

1106 / 1107

BIC® 4 COLOURS® SHINE
1106/1107

A SP: max. 2 col.
B LE
C LE
D LE: 360°
E SP: max. 1 col.

MOQ 250 units

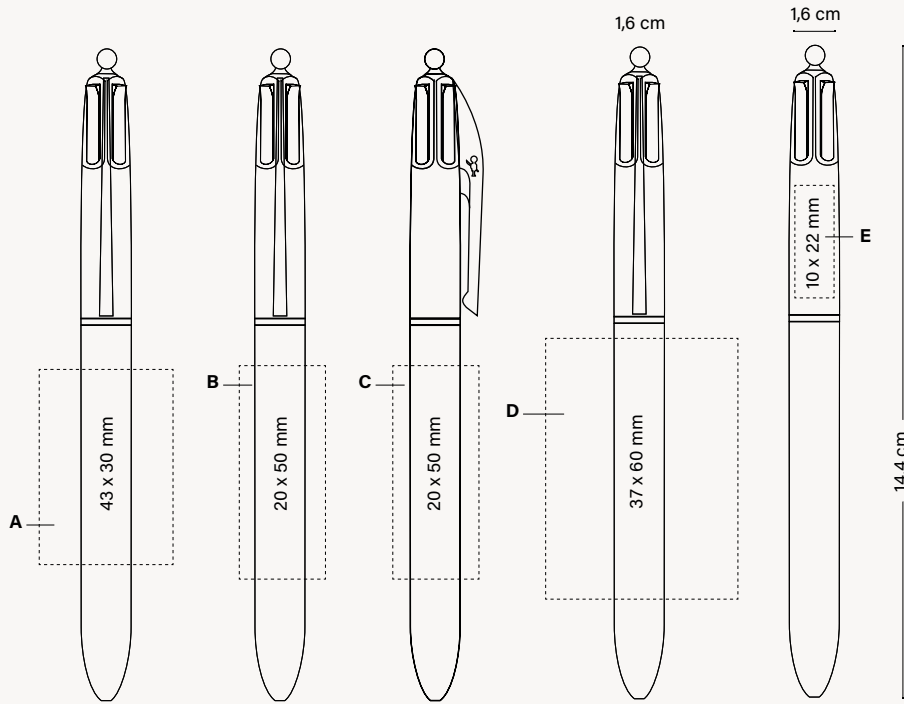

OPTIONAL SPECIAL PACKAGING



ECO SLEEVE

+ INFO PAGES 254 TO 265



PLASTIC POUCH



WINDOW BOX



BIC® COLLECTION BOX

Can be used as bookmark

(1, 2 & 3 units)

EXTERNAL PACKAGING



250 ± 3,2KG



PERSONALISED COLOURS



MANUFACTURED AND PRINTED IN BIC FACTORIES



MADE IN FRANCE



REGULATORY COMPLIANCE



ISO certified

WRITING MODES



BALLPEN M Ø1 MM

PRINTING TECHNIQUES



SCREEN PRINTING



LASER

SUSTAINABILITY



IMPRIM'VERT®



100% ELECTRICITY COMING FROM RENEWABLE SOURCES

BIC GRAPHIC

BIC® WRITING INSTRUMENTS

OTHER WRITING INSTRUMENTS

NOTEBOOKS

BIC® / DIIPEE® LIGHTERS AND BIC® CASES

BIC® PACKAGING

GENERAL INFORMATION

See pages 272-276 for a detailed explanation of the icons.



A soft touch you won't want to put down!

Feel it !

1060 / 1063

BIC® 4 COLOURS® SOFT

1060 Opaque

1063 With Lanyard

Ink Colour



01/03F



01/02F



02/02F



01/07F



Feel the softness
in your hands



Refill
service on
request

1:1 scale

FR /

Un toucher doux
que vous ne
lâcherez plus !

DE /

Eine samtige
Oberfläche, die Sie
nicht mehr aus der
Hand legen möchten.

IT /

Una superficie
morbida che non
vorrai mai smettere
di toccare!

ES /

¡Un tacto suave
que no querrás
dejar de tocar!

BIC® 4 COLOURS® SOFT

1060 / 1063

BIC® 4 COLOURS® SOFT

1060/1063

A SP: max. 1 col.

B SP: max. 1 col. (only for white upper parts)

MOQ 250 units

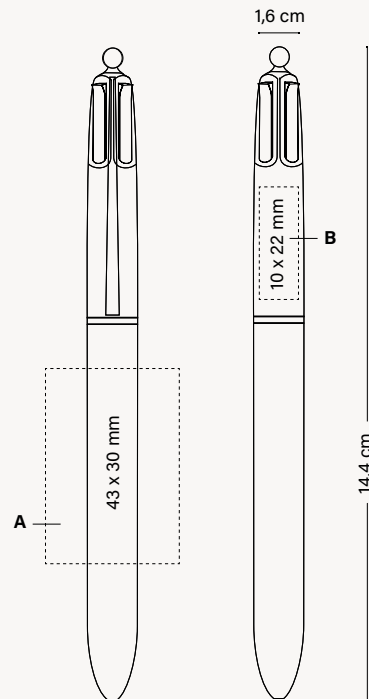

OPTIONAL SPECIAL PACKAGING



+ INFO PAGES 254 TO 265

Can be used as bookmark

(1, 2 & 3 units)

EXTERNAL PACKAGING



PERSONALISED COLOURS



MANUFACTURED AND PRINTED IN BIC FACTORIES



MADE IN FRANCE



REGULATORY COMPLIANCE



ISO certified

WRITING MODES



BALLPEN M Ø 1 MM

PRINTING TECHNIQUES



SCREEN PRINTING

SUSTAINABILITY



IMPRIM'VERT®



100% ELECTRICITY COMING FROM RENEWABLE SOURCES

BIC® GRAPHIC

BIC® WRITING INSTRUMENTS

OTHER WRITING INSTRUMENTS

NOTEBOOKS

BIC® / DIIPEE® LIGHTERS AND BIC® CASES

BIC® PACKAGING

GENERAL INFORMATION

See pages 272-276 for a detailed explanation of the icons.



Be impressed with the spectacular wood finish!

1061 / 1064

BIC® 4 COLOURS® WOOD STYLE

1061 Opaque

1064 With Lanyard

Ink Colour



Wood Vibes

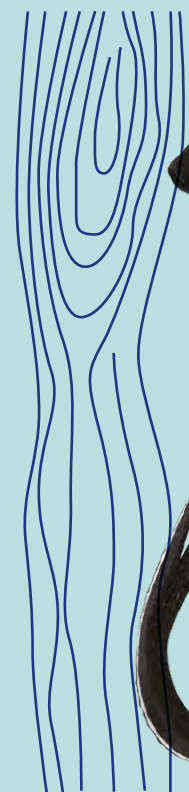

01/6AW



01/05W



02/6AW



01/02W



Bring warmth to your brand



Refill service on request

1:1 scale

FR /
Laissez-vous impressionner par cette finition spectaculaire !

DE /
Lassen Sie sich von der spektakulären Holzoptik beeindrucken!

IT /
Lasciatevi impressionare dalla spettacolare finitura in legno!

ES /
¡Déjate impresionar por el espectacular acabado efecto madera!

BIC® 4 COLOURS® WOOD STYLE

1061 / 1064

BIC® 4 COLOURS® WOOD STYLE

1061/1064

A SP: max. 2 col.

B SP: max. 1 col. (only for white upper parts)

MOQ 250 units

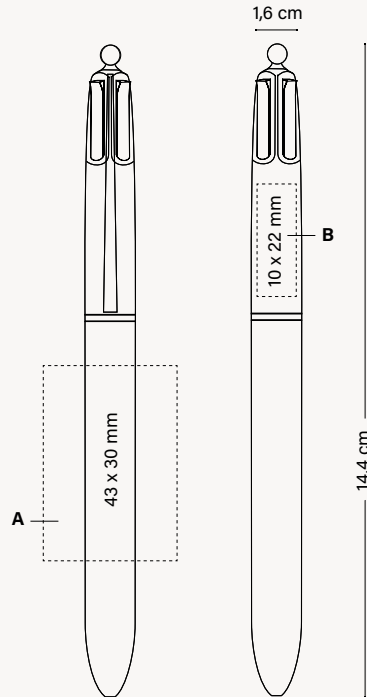

OPTIONAL SPECIAL PACKAGING



+ INFO PAGES 254 TO 265



Can be used as bookmark



(1, 2 & 3 units)

EXTERNAL PACKAGING



250 ± 3,2KG



PERSONALISED COLOURS



MANUFACTURED AND PRINTED IN BIC FACTORIES



MADE IN FRANCE



REGULATORY COMPLIANCE



ISO certified

WRITING MODES



BALLPEN M
Ø 1 MM

PRINTING TECHNIQUES



SCREEN PRINTING

SUSTAINABILITY



IMPRIM'VERT®



100% ELECTRICITY COMING FROM RENEWABLE SOURCES

BIC® GRAPHIC

BIC® WRITING INSTRUMENTS

OTHER WRITING INSTRUMENTS

NOTEBOOKS

BIC® / DIIPEE® LIGHTERS AND BIC® CASES

BIC® PACKAGING

GENERAL INFORMATION

See pages 272-276 for a detailed explanation of the icons.

Celebrate heritage.

1067 / 1068

BIC® 4 COLOURS® FLAGS COLLECTION

1067

1068 With Lanyard

Ink Colour



01/03/47/05



01/02/03/12



02/02/03/12



01/03/47/04



Refill service on request

1:1 scale

FR /
Célébrer le patrimoine !

DE /
Feiern Sie Ihre Geschichte!

IT /
Celebra la tradizione!

ES /
¡Celebra el legado!

BIC® 4 COLOURS® FLAGS COLLECTION

1067 / 1068

BIC® 4 COLOURS® FLAGS COLLECTION

1067/1068

A SP: max. 2 col.

B SP: max. 1 col. (only for white upper parts)

MOQ 250 units

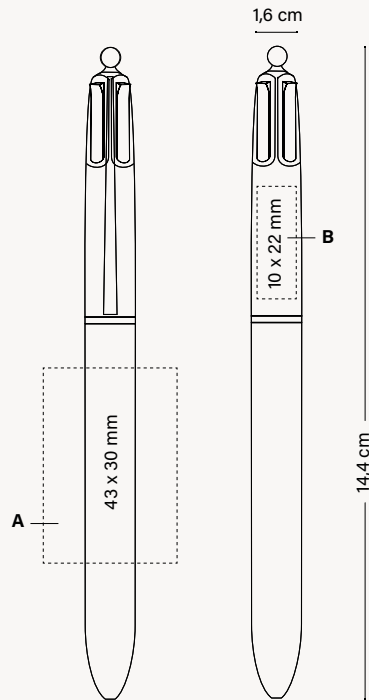

OPTIONAL SPECIAL PACKAGING



+ INFO PAGES 254 TO 265

Can be used as bookmark

(1, 2 & 3 units)

EXTERNAL PACKAGING



CHECK OUT THE VIDEO

See pages 272-276 for a detailed explanation of the icons.

BIC GRAPHIC

BIC® WRITING INSTRUMENTS

OTHER WRITING INSTRUMENTS

NOTEBOOKS

BIC® / DIIPEE® LIGHTERS AND BIC® CASES

BIC® PACKAGING

GENERAL INFORMATION

1099

BIC® 4 COLOURS® 3+1^{HB}
1099 Opaque

Ink Colour
● ● ● ●



Refill
service on
request



01/06

01/06

1:1 scale

BIC® 4 COLOURS® 3+1^{HB}

1099

BIC® 4 COLOURS® 3+1^{HB}

1099 Opaque

A/B LE

MOQ 250 units

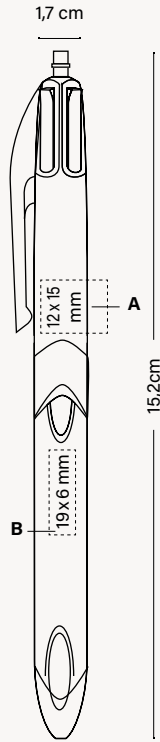

OPTIONAL SPECIAL PACKAGING



PLASTIC
POUCH

+ INFO PAGES 254 TO 265

*Can be used
as bookmark*



BIC®
COLLECTION
BOX

(1, 2 & 3 units)

EXTERNAL PACKAGING



250 ± 3,5 KG



PERSONALISED
COLOURS



MANUFACTURED
AND PRINTED IN
BIC FACTORIES



REGULATORY
COMPLIANCE



WRITING MODES



BALLPEN **M**
Ø 1 MM



MECHANICAL PENCIL
MP Ø 0,7MM

PRINTING TECHNIQUES



LASER

SUSTAINABILITY



IMPRIM'VERT®



100% ELECTRICITY
COMING FROM
RENEWABLE SOURCES



CHECK OUT THE VIDEO

BIC
GRAPHIC

BIC®
WRITING INSTRUMENTS

OTHER WRITING
INSTRUMENTS

NOTEBOOKS

BIC® / DIIPEE® LIGHTERS
AND BIC® CASES

BIC®
PACKAGING

GENERAL
INFORMATION

See pages 272-276 for a detailed explanation of the icons.

Metal accents and modern design, available in classic colors and a variety of finishes.

1290

BIC® METAL PRO
1290 Soft

Colour ink



01F



02F



04F



Maximum writing comfort



German ink for writing up to 8 km.

1:1 scale

FR /
Des accents métalliques et un design moderne, disponible en couleurs classiques et une variété de finitions.

DE /
Metallakzente und modernes Design, erhältlich in klassischen Farben und einer Vielzahl von Ausführungen.

IT /
Particolari metallici, design moderno, disponibile in colori classici e una varietà di finiture.

ES /
Detalles metálicos y diseño moderno, disponible en colores clásicos y una variedad de acabados.

Modern elegance

1290

BIC® METAL PRO
1290 Polished

Colour ink



01E



02E



04E



WRITING MODES



PRINTING TECHNIQUES



SUSTAINABILITY



See pages 272-276 for a detailed explanation of the icons.

1290

BIC® METAL PRO
1290 Matt

Colour ink
● ●



01D



02D



04D

1:1 scale

BIC® METAL PRO

1290

BIC® METAL PRO

1290

A SP: max. 2 col.
(Not available in soft finish)
B LE/SP: max. 1 col.
C LE 360°

MOQ 50 units

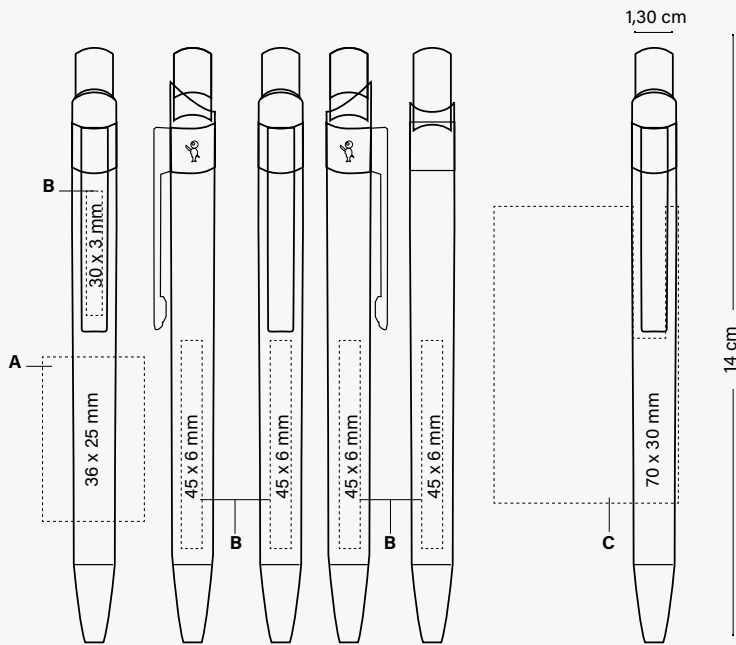

OPTIONAL SPECIAL PACKAGING



+ INFO PAGES 254 TO 265

*Can be used
as bookmark*

EXTERNAL PACKAGING



WRITING
MODES



PRINTING
TECHNIQUES



SUSTAINABILITY



BIC
GRAPHIC

BIC®
WRITING INSTRUMENTS

OTHER WRITING
INSTRUMENTS

NOTEBOOKS

BIC® / DIEEP® LIGHTERS
AND BIC® CASES

BIC®
PACKAGING

GENERAL
INFORMATION

See pages 272-276 for a detailed explanation of the icons.

BIC® ROLLERS AND GELS

Enjoy a smooth writing experience. Glide across the paper easily without smudging thanks to the quick-drying ink, ideal for both left and right-handed people.

FR/

Profitez d'une expérience d'écriture douce, fluide et de longue durée.

Parfait pour les droitiers comme pour les gauchers, il glisse facilement sur le papier et ne fait pas de tâches grâce à son encre à séchage rapide.

DE/

Genießen Sie das sanfte Schreiberlebnis.

Gleitet leicht über das Papier und dank der schnell trocknenden Tinte, ohne zu verschmieren. Ideal für Links- und Rechtshänder.

IT/

Goditi un'esperienza di scrittura morbidissima.

Scorri facilmente sulla carta senza macchiare grazie all' inchiostro ad asciugatura immediata, ideale per mancini.

ES/

Disfruta de una experiencia de escritura suave, fluida y de larga duración.

Se desliza fácilmente a través del papel y sin manchas gracias a la tinta de secado rápido, ideal tanto para las personas zurdas como diestras.

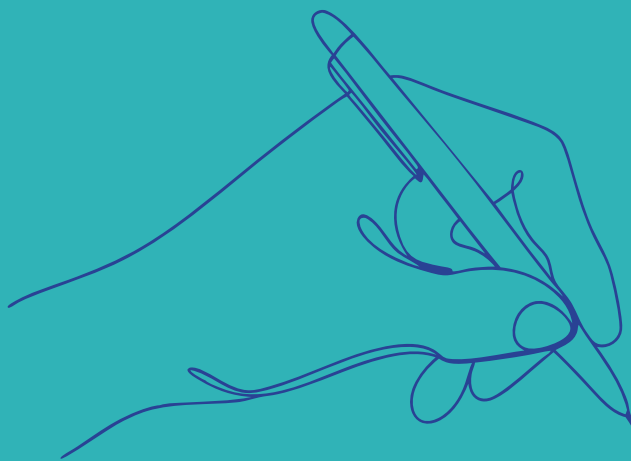



1187
BIC® Grip Roller



1196
BIC® Intensity® Gel Clic
Opaque



1196
BIC® Intensity® Gel Clic
Clear

Smooth
performance

BIC® GRIP ROLLER

1187



High quality medium point liquid ink roller pen for smooth and fluid writing

BIC® GRIP ROLLER

1187

Colour ink



01/35

Also available in blue ink



12/35



10/35



59/35



24/35



07/35

Also available in blue ink



06/35



27/35



02/35

Also available in blue ink



14/35

1:1 scale

BIC® GRIP ROLLER

1187

BIC® GRIP ROLLER

1187

A/B SP: max. 3 col.

MOQ 250 units

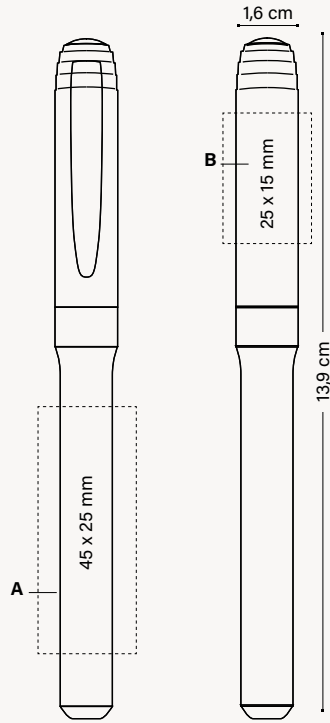

WRITING MODES



PRINTING TECHNIQUES



SUSTAINABILITY



OPTIONAL SPECIAL PACKAGING



+ INFO PAGES 254 TO 265



Can be used as bookmark



Can be used as bookmark



(1, 2 & 3 units)

EXTERNAL PACKAGING



BIC GRAPHIC

BIC® WRITING INSTRUMENTS

OTHER WRITING INSTRUMENTS

NOTEBOOKS

BIC® / DIEEP® LIGHTERS AND BIC® CASES

BIC® PACKAGING

GENERAL INFORMATION

See pages 272-276 for a detailed explanation of the icons.

1196



Iconic BIC® Boy is embossed

**BIC® INTENSITY®
GEL CLIC**

1196 Opaque

Colour ink



01



02

1:1 scale

1196

**BIC® INTENSITY®
GEL CLIC**

1196 Clear

Colour ink



92



88



86

1:1 scale

BIC® INTENSITY® GEL CLIC

1196

BIC® INTENSITY® GEL CLIC

1196

A SP: max. 2 col.

B SP: max. 4 col.

MOQ 250 units

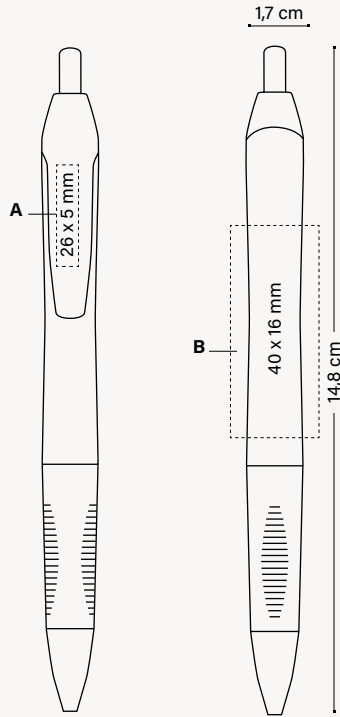

OPTIONAL SPECIAL PACKAGING



+ INFO PAGES 254 TO 265

*Can be used
as bookmark*

EXTERNAL PACKAGING



250 ± 3,7KG



MANUFACTURED
AND PRINTED IN
BIC FACTORIES



REGULATORY
COMPLIANCE



ISO
certified

WRITING
MODES



GEL G
Ø 0,7 MM

PRINTING
TECHNIQUES



SCREEN PRINTING

SUSTAINABILITY



IMPRIM'VERT®

BIC
GRAPHIC

BIC®
WRITING INSTRUMENTS

OTHER WRITING
INSTRUMENTS

NOTEBOOKS

BIC® / DIBEE® LIGHTERS
AND BIC® CASES

BIC®
PACKAGING

GENERAL
INFORMATION

See pages 272-276 for a detailed explanation of the icons.

BIC® HIGHLIGHTERS AND MARKERS

BIC® Markers offer you products specifically designed to write in a highly visible way and mark on surfaces or material that other writing instruments cannot mark on. Make your ideas visible and express yourself whatever the surface with BIC® Markers.

FR/

Les surligneurs et les marqueurs BIC® ont été conçus pour écrire d'une manière visible sur une large gamme de surfaces. Exprimez-vous avec clarté sur n'importe quelle surface.

DE/

BIC®-Textmarker sind Produkte, die speziell konzipiert wurden, um besonders sichtbar zu schreiben und auf Oberflächen oder Materialien zu markieren, wo herkömmliche Schreibgeräte an ihre Grenzen stoßen.

IT/

BIC® ti offre prodotti appositamente progettati per scrivere in modo ben visibile su superfici e materiali su cui altri strumenti di scrittura non possono scrivere. Rendi visibili le tue idee ed esprimiti su qualsiasi superficie con pennarelli BIC®.

ES/

Los subrayadores y marcadores BIC® están diseñados para escribir visiblemente en un amplio rango de superficies. Exprésate con claridad sin importar la superficie.

Mark it



1192
BIC® Brite Liner® Grip
Opaque



1132
BIC® Highlighter Flat



1651
BIC® Velleda® White
Board Marker Fine



1213
BIC® Velleda® White
Board Marker Grip



1214
BIC® Mark-it
Permanent Marker



1214
BIC® Mark-it
Permanent Marker

Underline it



1192

BIC® BRITE LINER® GRIP
1192



Bright colours to highlight or underline your ideas.

TWO WIDTHS:
Fine 1.6 mm and
Large 3.3 mm.



Textured rubberised grip for more precision and control

Water-based ink.



- 12 Colour ink
- 10 Colour ink
- 24 Colour ink
- 59 Colour ink
- 14 Colour ink

1:1 scale

BIC® BRITE LINER® GRIP

1192

BIC® BRITE LINER® GRIP

1192

A/B SP: max. 3 col.

MOQ 250 units

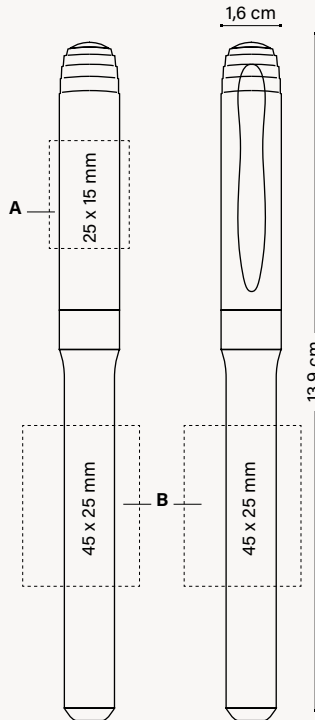

OPTIONAL SPECIAL PACKAGING



+ INFO PAGES 254 TO 265

Can be used
as bookmark



(1, 2 & 3 units)

EXTERNAL PACKAGING



250 ± 2,8KG



WILL NOT DRY OUT IN 24H

WRITING
MODES



HIGHLIGHTER HL

PRINTING
TECHNIQUES



SCREEN PRINTING

SUITABLE FOR



FAXES



PHOTOCOPIES



PRINTERS



PAPER

SUSTAINABILITY



IMPRIM'VERT®

BIC
GRAPHIC

BIC®
WRITING INSTRUMENTS

OTHER WRITING
INSTRUMENTS

NOTEBOOKS

BIC® / DIEEP® LIGHTERS
AND BIC® CASES

BIC®
PACKAGING

GENERAL
INFORMATION

See pages 272-276 for a detailed explanation of the icons.

NEW!

1132

BIC® HIGHLIGHTER FLAT
1132



12

Colour ink



10

Colour ink



59

Colour ink



14

Colour ink

1:1 scale



UNDERLINING IN TWO WIDTHS:
Fine 1.2 mm and Large 4.6 mm.

*Water-Based Dye Ink.
Ultra fluorescent ink with up to 95% natural origin.*

BIC® HIGHLIGHTER FLAT

1132

BIC® HIGHLIGHTER FLAT

1132

A BP : full-colour

MOQ 250 units

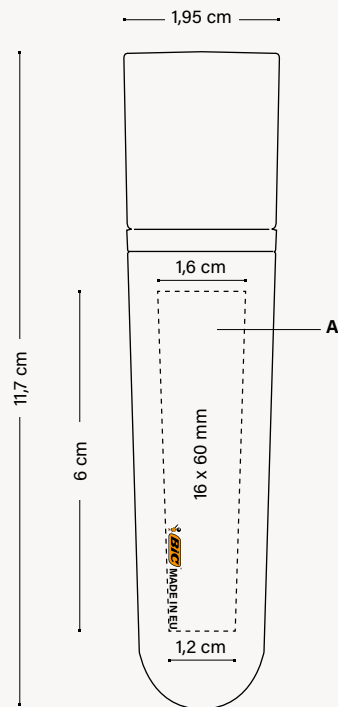

EXTERNAL PACKAGING



WRITING MODES



PRINTING TECHNIQUES



SUSTAINABILITY



BIC
GRAPHIC

BIC®
WRITING INSTRUMENTS

OTHER WRITING
INSTRUMENTS

NOTEBOOKS

BIC® / D'JEEP® LIGHTERS
AND BIC® CASES

BIC®
PACKAGING

GENERAL
INFORMATION

See pages 272-276 for a detailed explanation of the icons.

BIC® VELLEDA® WHITE BOARD MARKER FINE

Velleda®

1651

BIC® VELLEDA® WHITE BOARD MARKER FINE
1651



01/04
Colour ink



01/02
Colour ink

1/1 scale

1651

BIC® VELLEDA® WHITE BOARD MARKER FINE
1651

A SP: max. 1 col.

MOQ 500 units

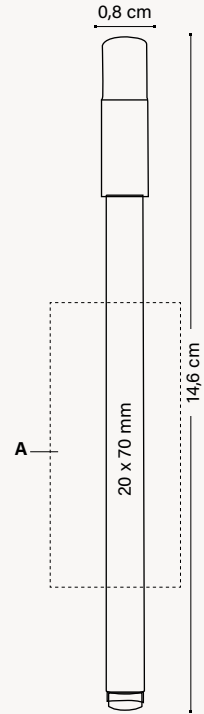

OPTIONAL SPECIAL PACKAGING



MARKING SET

Now you can have it as a set!

+ INFO PAGES 254 TO 265

Can be used as bookmark

EXTERNAL PACKAGING



500 ± 3,2KG



MANUFACTURED AND PRINTED IN BIC FACTORIES



REGULATORY COMPLIANCE

FABRIQUÉ EN FRANCE

MADE IN FRANCE



RESISTANT TIP



WRITING MODES



MARKER MK

PRINTING TECHNIQUES



SCREEN PRINTING

SUSTAINABILITY



IMPRIM'VERT®



1213

BIC® VELLEDA® WHITE BOARD MARKER GRIP
1213



→
Textured rubberised grip for more precision and control

1:1 scale

01/02
●
Colour ink

1213

BIC® VELLEDA® WHITE BOARD MARKER GRIP
1213

A/B SP: max. 3 col.

MOQ 250 units

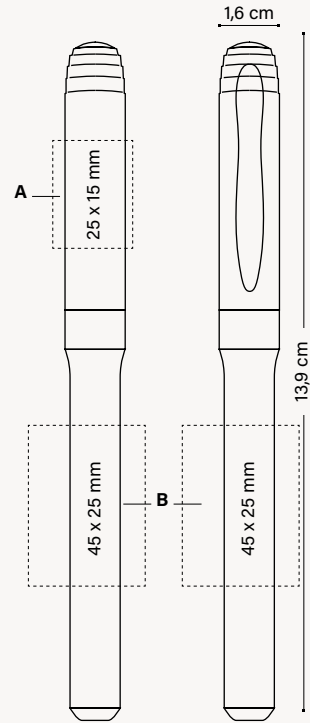

OPTIONAL SPECIAL PACKAGING



MARKING SET

Now you can have it as a set!

+ INFO PAGES 254 TO 265

Can be used as bookmark

EXTERNAL PACKAGING



250 ± 2,7KG



MANUFACTURED AND PRINTED IN BIC FACTORIES



RESISTANT TIP



REGULATORY COMPLIANCE

WRITING MODES



MARKER MK

PRINTING TECHNIQUES



SCREEN PRINTING

SUSTAINABILITY



BIC® MARK-IT PERMANENT MARKER

1214

**BIC® MARK-IT
PERMANENT
MARKER**
1214



01/02
●
Colour ink

01/04
●
Colour ink

1:1 scale

←
*Textured rubberised
grip for more
precision and control*

1214

**BIC® MARK-IT
PERMANENT MARKER**
1214

A/B SP: max. 3 col.

MOQ 250 units

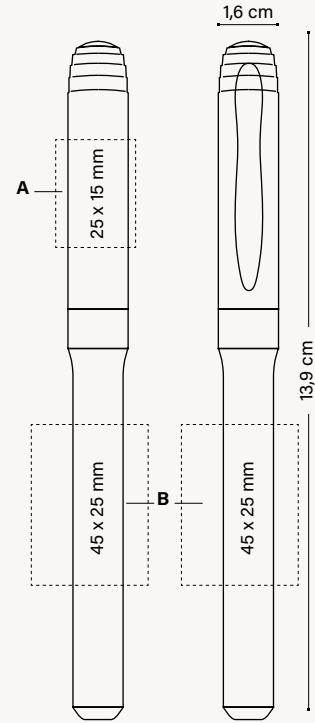

OPTIONAL SPECIAL PACKAGING



MARKING
SET

*You can have
it as a set!*

+ INFO PAGES 254 TO 265

*Can be used
as bookmark*

EXTERNAL PACKAGING



250 ± 2,8KG



MANUFACTURED
AND PRINTED IN
BIC FACTORIES



RESISTANT
TIP

WRITING MODES



MARKER
MK

PRINTING TECHNIQUES



SCREEN
PRINTING

SUSTAINABILITY



IMPRIM'VERT®

BIC® PERMANENT MARKER ECOLUTIONS®

ecolutions



*Excluding ink system

MADE FROM **52% RECYCLED MATERIAL***

Add the Möbius loop to your artwork at no additional charge. Please specify "Print the Möbius loop" on your order. (Möbius loop imprint defaults to left-hand hand corner.)



PHARMACEUTICAL WASTE

1210

BIC® PERMANENT MARKER
ecolutions® 1210



1:1 scale

02

●
Colour ink

02

●
Colour ink

1210

BIC® PERMANENT MARKER
ecolutions® 1210

A SP: max. 1 col.

MOQ 250 units

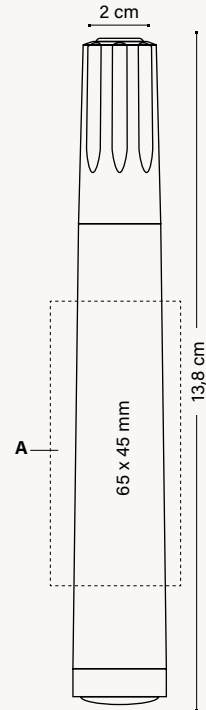

EXTERNAL PACKAGING



MANUFACTURED AND PRINTED IN BIC FACTORIES



REGULATORY COMPLIANCE

FABRIQUÉ EN FRANCE MADE IN FRANCE



RESISTANT TIP



WRITING MODES



MARKER MK

PRINTING TECHNIQUES



SCREEN PRINTING

SUSTAINABILITY



PHARMACEUTICAL WASTE



ecolutions®

*The percentage is calculated on total weight of product excluding ink system. Due to the recycled content of the raw materials used to make the product, we cannot guarantee that the colours shown in the catalogue or colours customised to order will always have the same colour and appearance.

BIC® MECHANICAL PENCILS

Stay sharp with these first-class
mechanical pencils!
They're solid and resistant.

FR/

**Toujours prêts avec ces porte-mines
de grande qualité.**

Ils sont solides et leurs mines sont résistantes.

DE/

**Stets schreibbereit mit diesen
Qualitäts-Druckbleistiften.**

Solide und resistent.

IT/

**Sempre pronti con i nostri portamine
di qualità superiore.**

Sono solidi e resistenti.

ES/

**Siempre preparados con estos
portaminas de calidad superior.**

Son sólidos y resistentes.

Always Sharp

BIC® MECHANICAL PENCILS FAMILY



1120
BIC® Matic®
Opaque



1028
BIC® Media Clic
Mechanical Pencil Opaque



1028
BIC® Media Clic
Mechanical Pencil Frosted



1021
BIC® Media Clic Grip
Mechanical Pencil Frosted



1E21
BIC® Media Clic Grip Ecolutions®
Mechanical Pencil Opaque

BIC
GRAPHIC

BIC®
WRITING INSTRUMENTS

OTHER WRITING
INSTRUMENTS

NOTEBOOKS

BIC® / DIEEP® LIGHTERS
AND BIC® CASES

BIC®
PACKAGING

GENERAL
INFORMATION

1120

BIC® MATIC®
1120 Opaque



**The percentage is calculated based on the total weight of the mechanical pencil excluding lead. Due to the recycled content of the raw materials used to make the product, we cannot guarantee that the colours shown in the catalogue or colours customised to order will always have the same colour and appearance.*

1120

BIC® MATIC®
1120

A SP: max. 1 col.
B/C: max. 2 col.

MOQ 500 units

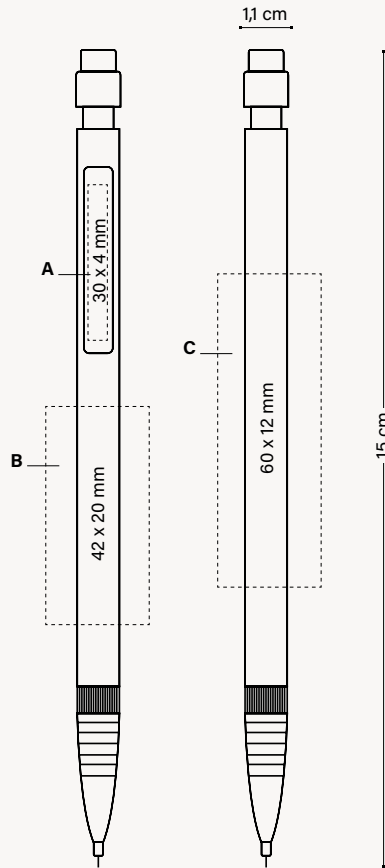

OPTIONAL SPECIAL PACKAGING



PLASTIC
POUCH

+ INFO PAGES 254 TO 265

*Can be used
as bookmark*

EXTERNAL PACKAGING



500 ± 3,1 KG



WRITING MODES

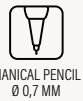

PRINTING TECHNIQUES



SUSTAINABILITY



BIC® MEDIA CLIC MECHANICAL PENCIL

1028  *Iconic BIC® Boy is embossed*

BIC® MEDIA CLIC
1028 Mechanical pencil
Opaque



5C

1/1 scale

1028

BIC® MEDIA CLIC
1028 Mechanical pencil
Frosted



39

1/1 scale

BIC® MEDIA CLIC GRIP MECHANICAL PENCIL

ECO version and standard at the same price!

ecolutions®

MADE FROM **98% RECYCLED MATERIAL***
*From barrel

98%

PLASTIC CAR PARTS

1021

BIC® MEDIA CLIC GRIP
1021 Mechanical pencil
Frosted



1E21

BIC® MEDIA CLIC GRIP
ecolutions® 1E21 Mechanical pencil
Opaque



* The percentage is calculated based on total weight of the barrel. Due to the recycled content of the raw materials used to make the product, we cannot guarantee that the colours shown in the catalogue or colours customised to order will always have the same colour and appearance.

BIC® MEDIA CLIC MECHANICAL PENCIL

1028

BIC® MEDIA CLIC
1028 Mechanical pencil

1021 / 1E21

BIC® MEDIA CLIC GRIP
1021 Mechanical pencil
ecolutions® 1E21 Mechanical pencil

MIX & MATCH No extra charge

MOQ 500 units
Standard colours combination

Clip



Opaque

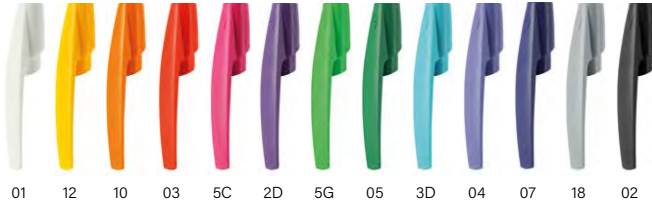

Frosted



01 12 10 03 5C 2D 5G 05 3D 04 07 18 02 69

Barrel



Opaque



5C

Frosted



39

Barrel & Grip

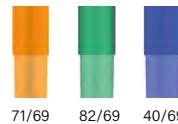

71/69 82/69 40/69

britePix DIGITAL THE SOLUTION FOR FULL COLOUR COMMUNICATION!

ecolutions®



Standard colours combination*

Barrel & Grip

Opaque



01/03 01/05 01/07 01/02



*From barrel
Add the Möbius loop to your artwork at no additional charge. Please specify "Print the Möbius loop" on your order. (Möbius loop imprint defaults to left-hand corner.)

All colour range available in Digital britePix™

Exact colour match: ≥ 10.000 units 1028
Exact colour match: ≥ 20.000 units 1021 / 1E21

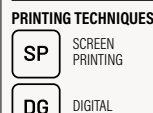

See pages 274-277 for a detailed explanation of the icons. *Due to the recycled content of the raw materials used to make the product, we cannot guarantee that the colours shown in the catalogue or colours customised to order will always have the same colour and appearance.

BIC® MEDIA CLIC MECHANICAL PENCIL

1028

BIC® MEDIA CLIC
1028 Mechanical pencil

A SP: max. 4 col.
B SP: max. 2 col.
C DG: full-colour

MOQ 500 units.

1021 / 1E21

BIC® MEDIA CLIC GRIP
1021 Mechanical pencil
ecolutions® 1E21 Mechanical pencil

D SP: max. 4 col.
E SP: max. 2 col.
F DG: full-colour

MOQ 500 units.

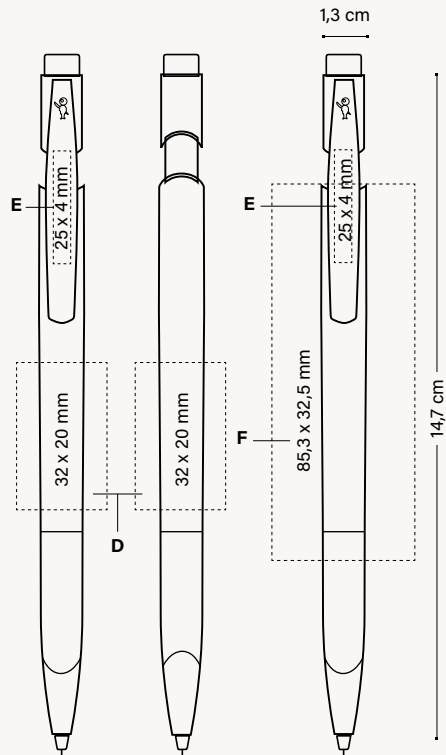
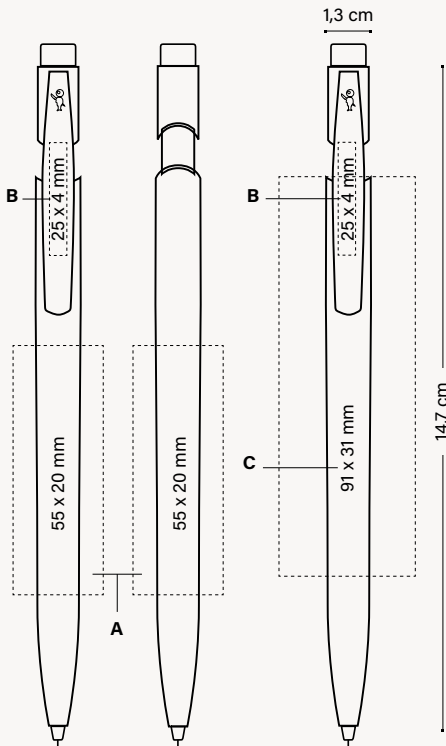

OPTIONAL SPECIAL PACKAGING



ECO SLEEVE



PLASTIC POUCH



WINDOW BOX

+ INFO PAGES 254 TO 265

Can be used as bookmark

EXTERNAL PACKAGING



500 ± 4,1 KG

OPTIONAL SPECIAL PACKAGING



ECO SLEEVE



PLASTIC POUCH



WINDOW BOX

+ INFO PAGES 254 TO 265

Can be used as bookmark

EXTERNAL PACKAGING



500 ± 4,3 KG



MANUFACTURED AND PRINTED IN BIC FACTORIES



MADE IN SPAIN

WRITING MODES



MECHANICAL PENCIL MP

PRINTING TECHNIQUES



SCREEN PRINTING



DIGITAL

SUSTAINABILITY



PLASTIC CAR PARTS

See pages 272-276 for a detailed explanation of the icons.

GENERAL INFORMATION

BIC® PACKAGING

BIC® / DIEEP® LIGHTERS AND BIC® CASES

NOTEBOOKS

OTHER WRITING INSTRUMENTS

BIC® WRITING INSTRUMENTS

BIC GRAPHIC

BIC® PENCILS & BIC® KIDS EVOLUTION® COLOURING SET

Graphite and colouring pencils made from synthetic resin and wood-free, that will not splinter in the event of breaking.

FR/

Crayons BIC® et BIC® Kids Evolution® Colouring set.

Crayons de graphite et de couleur fabriqués en résine synthétique et sans bois, qui ne font pas d'écharde en cas de brisure.

DE/

BIC® Bleistifte und BIC® Kids Evolution® Colouring Set.

Graphit- und Farbstifte aus synthetischem Harz und ohne Holz, die bei Bruch nicht splintern.

IT/

Matite BIC® e BIC® Kids Evolution® Colouring set.

Matite di grafite e colorate realizzate in resina sintetica e senza legno, che non scheggiano in caso di rottura.

ES/

Lápices BIC® y BIC® Kids Evolution® Colouring set.

Lápices de grafito y de colores fabricados con resina sintética y sin madera, que no se astillan en caso de romperse.





1150
Graphite Pencil
Cut end Ecolutions®



1151
Graphite Pencil
With eraser Ecolutions®



1607
BIC® Kids Evolution®
Colouring set Ecolutions®



53062
Sprout™ Graphite Pencil

Evolution® eColutions®



THE SOLUTION FOR FULL COLOUR COMMUNICATION!



THE SOLUTION FOR FULL COLOUR COMMUNICATION!



Embossed iconic BIC® brand!



MADE FROM 64% RECYCLED MATERIAL*



FRIDGES AND YOGURT POTS



MADE FROM 52% RECYCLED MATERIAL*



FRIDGES AND YOGURT POTS

1150

GRAPHITE PENCIL CUT END
eColutions® 1150

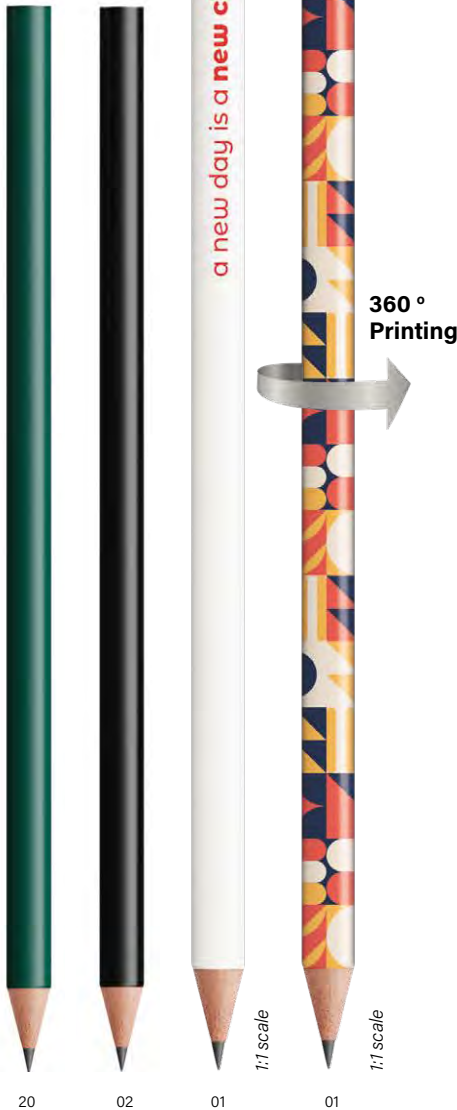

Protective sheath

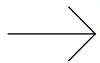

1151

GRAPHITE PENCIL WITH ERASER
eColutions® 1151

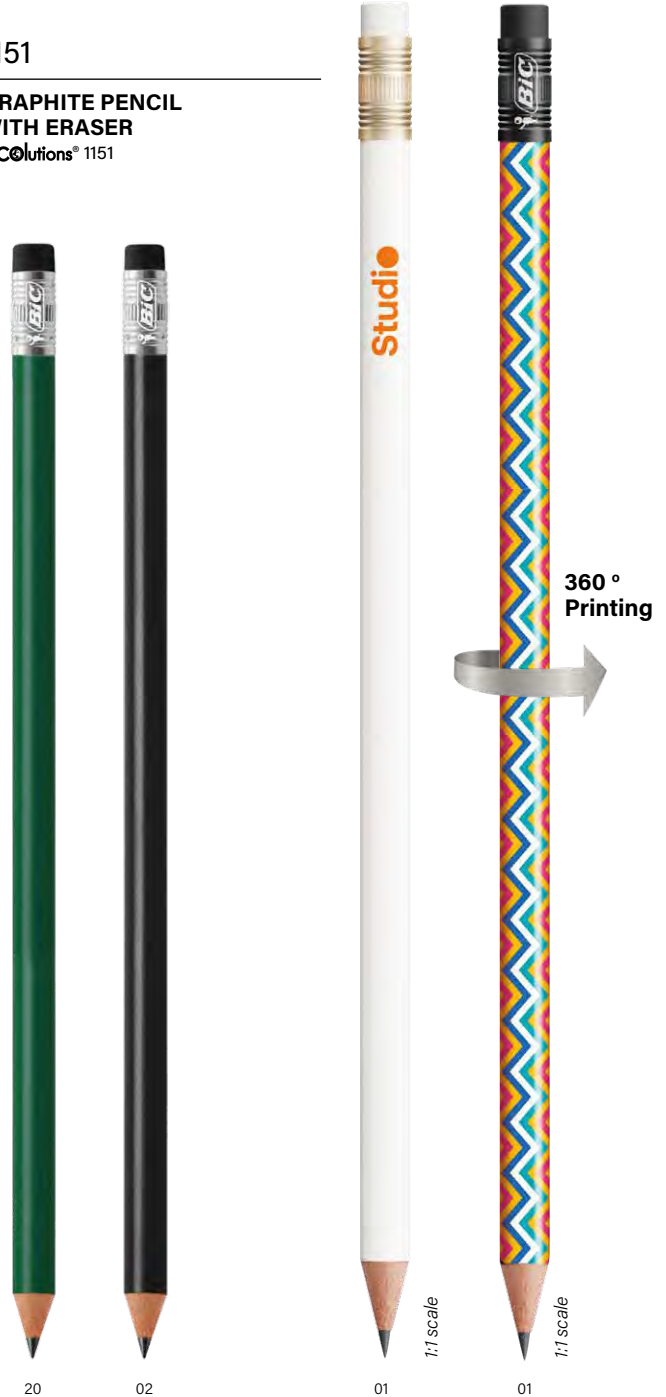

*The percentage is calculated based on total weight of the product. Due to the recycled content of the raw materials used to make the product, we cannot guarantee that the colours shown in the catalogue or colours customised to order will always have the same colour and appearance.



MADE FROM UP TO
64% RECYCLED MATERIAL*



Add the Möbius loop to your artwork at no additional charge. Please specify it on your order. (Möbius loop imprint defaults to left-hand hand corner.)**

1150 / 1151

GRAPHITE PENCIL

1150 / 1151

MIX & MATCH No extra charge

MOQ 500 units
Standard colours combination

Eraser

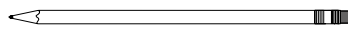

Opaque



Ferrule

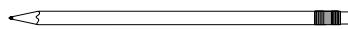

Opaque



Barrel



Opaque

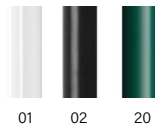

MIX & MATCH



MANUFACTURED AND PRINTED IN BIC FACTORIES

FABRIQUÉ EN FRANCE

MADE IN FRANCE



REGULATORY COMPLIANCE



ISO certified



RESISTANT TIP



NO SPLINTER



PROTECTIVE SHEATH



EASY TO USE AND ERASE

WRITING MODES



PENCIL PC HB 0,2,3MM

PRINTING TECHNIQUES



SCREEN PRINTING



DIGITAL

SUSTAINABILITY



BIC GRAPHIC

BIC® WRITING INSTRUMENTS

OTHER WRITING INSTRUMENTS

NOTEBOOKS

BIC® / DEEP® LIGHTERS AND BIC® CASES

BIC® PACKAGING

GENERAL INFORMATION

**Percentage indicated in the Möbius loop depend on the product selected (1150 or 1151). Please, see details at the product description.



1150

BIC® EVOLUTION® ECOLUTIONS®
ecolutions® 1150 (Pencil cut end)

A SP: max. 1 col.

MOQ 500 units

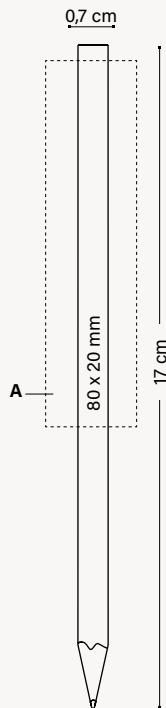

1151

BIC® EVOLUTION® ECOLUTIONS®
ecolutions® 1151 (Pencil with eraser)

MOQ 500 units

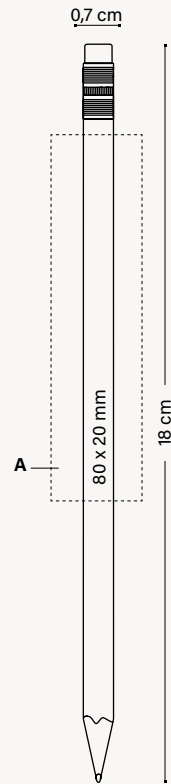

OPTIONAL SPECIAL PACKAGING



+ INFO PAGES 254 TO 265

*Can be used
as bookmark*

EXTERNAL PACKAGING



1150

BIC® EVOLUTION® ECOLUTIONS®
ecolutions® 1150 (Pencil cut end Digital)

A DG: full-colour (area for images)

MOQ 500 units

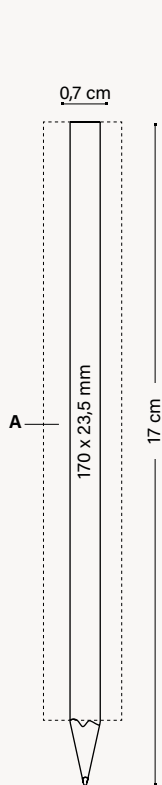

1151

BIC® EVOLUTION® ECOLUTIONS®
ecolutions® 1151 (Pencil with eraser Digital)

MOQ 500 units

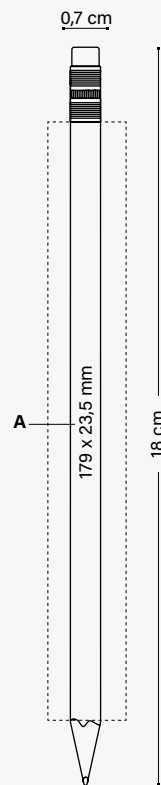

OPTIONAL SPECIAL PACKAGING



+ INFO PAGES 254 TO 265

Can be used as bookmark

EXTERNAL PACKAGING



WRITING MODES



PRINTING TECHNIQUES



SUSTAINABILITY



BIC GRAPHIC

BIC® WRITING INSTRUMENTS

OTHER WRITING INSTRUMENTS

NOTEBOOKS

BIC® / BIC® LIGHTERS AND BIC® CASES

BIC® PACKAGING

GENERAL INFORMATION

See pages 272-276 for a detailed explanation of the icons.

BIC® KIDS EVOLUTION® COLOURING SET



Ultra-resistant Wood-free pencils that are easy to sharpen.
Ideal for everyday drawing and colouring.

FABRIQUÉ
EN FRANCE
MADE IN FRANCE



Safe usage
for kids

- Does not splinter on breaking
- Resistant to chewing

Fully customisable
cardboard box**



*Excluding lead

MADE FROM
51% RECYCLED MATERIAL*



FRIDGES AND
YOGURT POTS

1607

BIC® KIDS EVOLUTION® COLOURING SET
6 UNITS
eColutions® 1607

NEW!



1609

BIC® KIDS EVOLUTION® COLOURING SET
12 UNITS
eColutions® 1609



*The percentage is calculated based on the total weight of the pencil excluding lead.

**Non-personalisable pencils

BIC® KIDS EVOLUTION® COLOURING SET

1607

BIC® KIDS EVOLUTION® COLOURING SET
ecolutions® 1607

A DG: full-colour
 MOQ 500 units.

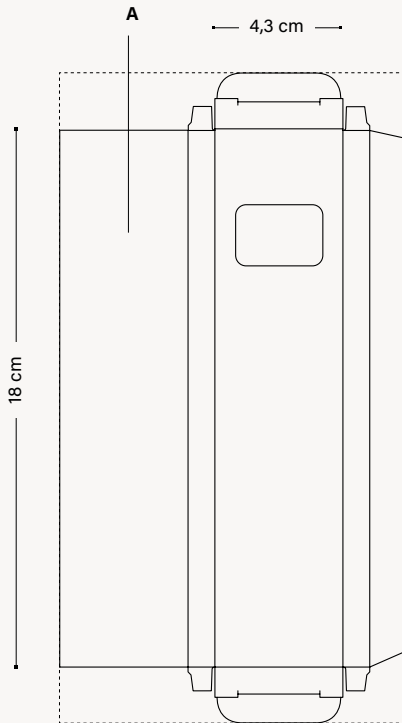

EXTERNAL PACKAGING



1609

BIC® KIDS EVOLUTION® COLOURING SET
ecolutions® 1609

A DG: full-colour
 MOQ 500 units.

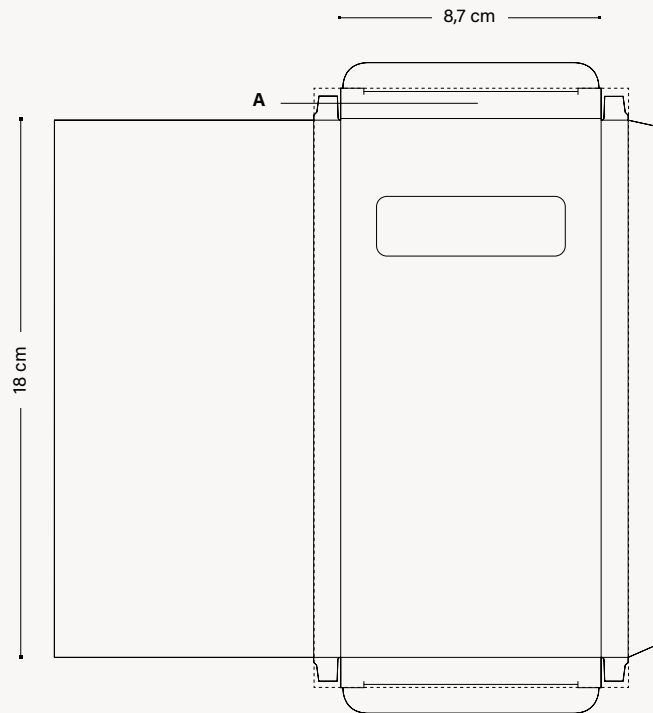

EXTERNAL PACKAGING



MANUFACTURED AND PRINTED IN BIC FACTORIES



MADE IN FRANCE



REGULATORY COMPLIANCE



RESISTANT TIP



NO SPLINTER



PROTECTIVE SHEATH

WRITING MODES



COLOURING PENCIL
 Ø 3,05MM

SUSTAINABILITY



IMPRIM'VERT®

ecolutions®



FRIDGES AND YOGURT POTS

BIC GRAPHIC

BIC® WRITING INSTRUMENTS

OTHER WRITING INSTRUMENTS

NOTEBOOKS

BIC® / DEEPP® LIGHTERS AND BIC® CASES

BIC® PACKAGING

GENERAL INFORMATION

See pages 272-276 for a detailed explanation of the icons.

SPROUT™ GRAPHITE PENCIL



The sustainable pencil that you can plant after use and grow into herbs, vegetables, fruits or flowers. This pencil enables you to convey a meaningful message and sets the foundation for a lasting relationship.

FR
Le crayon durable que vous pouvez planter après son utilisation et faire pousser des plantes, des légumes, des fruits ou des fleurs.

DE
Der nachhaltige Bleistift kann nach Gebrauch eingepflanzt werden, um sich in Kräuter, Obst, Gemüse oder Blumen zu verwandeln. Dieser Stift ermöglicht es Ihnen, tiefgreifende Botschaften zu übermitteln und legt den Grundstein für dauerhafte Beziehungen.

IT
La matita sostenibile che può essere piantata dopo essere stata utilizzata e cresce come un'erba, un vegetale, un frutto o un fiore.

ES
El lápiz sostenible que puedes plantar después de ser utilizado y crece como una hierba, un vegetal, una fruta o una flor.

53062

SPROUT™ GRAPHITE PENCIL 53062

Contains seeds

FR/ contient des graines
DE/ enthält Samen
IT/ contiene semi
ES/ contiene semillas

Plant after use and make it sprout



FR/ Plantez après utilisation et faites-le germer.
DE/ Pflanze nach Gebrauch und lass sie sprießen.
IT/ Piantalo dopo l'uso e fallo germogliare.
ES/ Plántalo después de usarlo y haz que brote.



Standard cardboard!

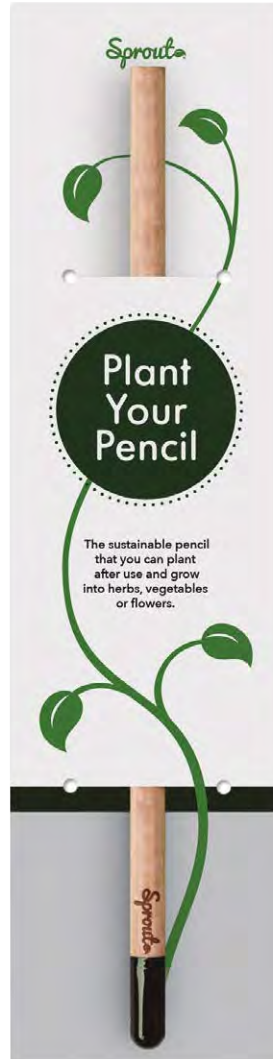

Standard cardboard packaging

Customisable cardboard!



Personalised cardboard packaging



Rear side



Graphite Lead

FR/ Mine de graphite.
DE/ Graphitmine
IT/ Mina di grafite.
ES/ Mina de grafito.

Once the pencil is too short to write with, plant the stub and watch your message turn into a pot of beautiful herbs, flowers, fruits or vegetables. **Choose between 9 different seeds!**

FR/ Une fois que le crayon est trop court pour écrire, plantez-le et regardez votre message se transformer en un pot de belles herbes, fleurs, fruits ou légumes. **Choisissez parmi 9 graines différentes!**

DE/ Sobald der Bleistift zu kurz zum Schreiben ist, pflanze den Stummel ein und beobachte, wie sich deine Botschaft in einen Topf mit schönen Kräutern, Blumen, Früchten oder Gemüse verwandelt. **Wähle zwischen 9 verschiedenen Samen!**

IT/ Quando la matita è troppo corta per scrivere, pianta il mozzicone e guarda il tuo messaggio trasformarsi in un vaso di bellissime erbe aromatiche, fiori, frutta o verdura. **Scegli tra 9 diversi semi!**

ES/ Cuando el lápiz sea demasiado corto para escribir, planta el trozo que queda y observa cómo tu mensaje se convierte en una maceta llena de hermosas hierbas, flores, frutas o verduras. **¡Elige entre 9 semillas diferentes!**

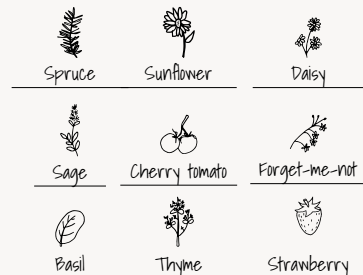

SPROUT™ GRAPHITE PENCIL

53062

SPROUT™ GRAPHITE PENCIL

53062

A LE
B DG

MOQ 100 units



Pencil sharpening is offered at an extra charge

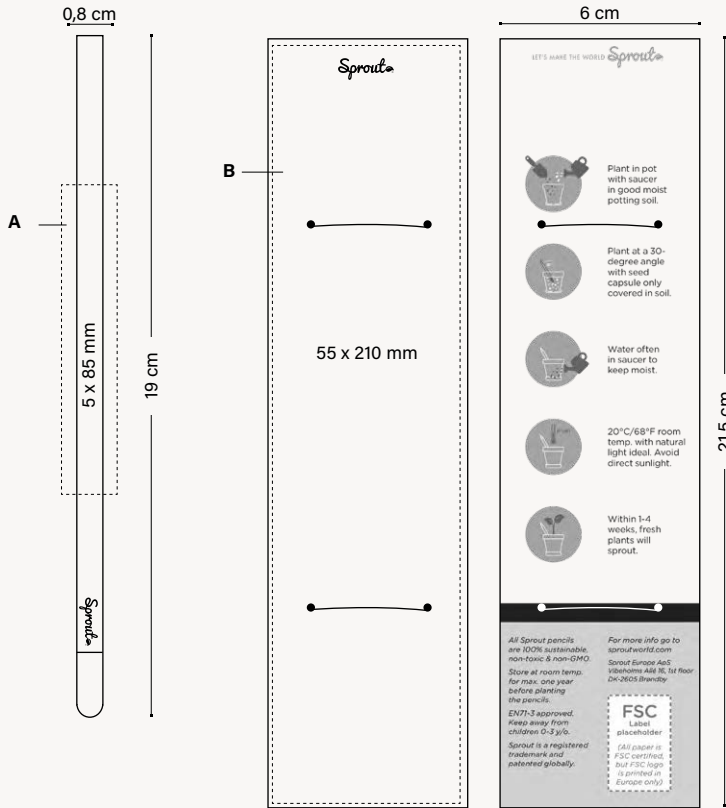

Planting instructions included on the rear side. For customised cardboard, you can change the font and colours!

EXTERNAL PACKAGING



Sprout™ Graphite Pencil without cardboard:

500 ± 2,37 KG

Sprout™ Graphite Pencil with cardboard:

100 ± 0,92 KG

PACKAGING



Sprout



WRITING MODES



PENCIL PC HB
Ø 2,3MM

PRINTING TECHNIQUES



SUSTAINABILITY



FSC AND RECYCLABLE CARDBOARD



CHECK OUT THE VIDEO

BIC GRAPHIC

BIC WRITING INSTRUMENTS

OTHER WRITING INSTRUMENTS

NOTEBOOKS

BIC / DEEPP LIGHTERS AND BIC CASES

BIC PACKAGING

GENERAL INFORMATION

See pages 272-276 for a detailed explanation of the icons.

Please consult your sales representative for details on language availability.

FR/ Veuillez consulter votre représentant commercial pour plus de détails sur les langues disponibles.
DE/ Bitte wenden Sie sich an Ihren Vertriebsmitarbeiter, um Einzelheiten zur Verfügbarkeit von Sprachen zu erfahren.
IT/ Per ulteriori dettagli sulla disponibilità delle lingue, si prega di consultare il proprio rappresentante commerciale.
ES/ Consulte a su representante de ventas para obtener más información sobre la disponibilidad de idiomas.

OTHER WRITING INSTRUMENTS

02

Reliable simplicity for everyday writing.

Lightweight and practical, these plastic pens combine functionality and comfort while meeting our quality standards. Choose the option that best suits your brand or style.

FR/

Fiabilité au quotidien, style sans effort.

Notre collection de stylos en plastique allie fonctionnalité, confort et design moderne. Légers mais résistants. Choisissez parmi une large gamme de couleurs et de finitions pour trouver celui qui correspond parfaitement à votre marque ou à votre style personnel.

DE/

Zuverlässigkeit im Alltag, müheloser Stil.

Unsere Kollektion an Kunststoffstiften vereint Funktionalität, Komfort und modernes Design. Leicht und dennoch strapazierfähig. Wählen Sie aus einer großen Auswahl an Farben und Oberflächen, um die perfekte Ergänzung für Ihre Marke oder Ihren persönlichen Stil zu finden.

IT/

Affidabilità quotidiana, stile senza sforzo.

La nostra collezione di penne in plastica combina funzionalità, comfort e design moderno. Leggere ma resistenti. Scegli tra un'ampia gamma di colori e finiture per trovare quella perfetta per il tuo marchio o il tuo stile personale.

ES/

Fiabilidad diaria, estilo sin esfuerzo.

Nuestra colección de bolígrafos de plástico combina funcionalidad, comodidad y diseño moderno. Ligeros pero resistentes. Elije entre una amplia gama de colores y acabados para encontrar el que mejor se adapte a tu marca o estilo.



12010
Basic Pen



11748
Click Pen



11243
Striped Grip Pen

Simple and
practical choice

BASIC PEN

12010

BASIC PEN

12010

Colour ink



BASIC PEN

12010

BASIC PEN
12010

A/B SP: max. 1 col.

MOQ 500 units

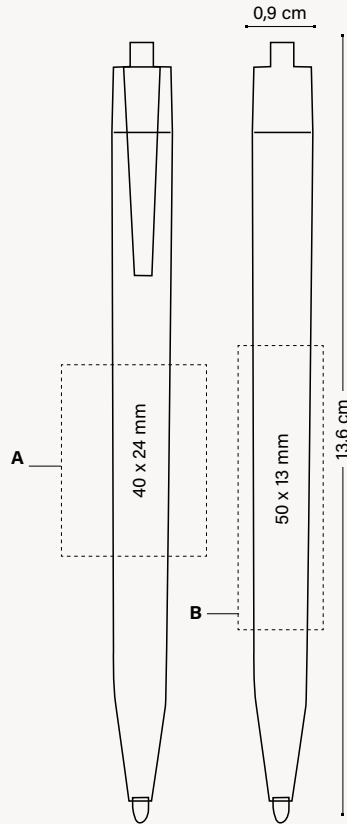

EXTERNAL PACKAGING



1000 ± 12,5 KG



WRITING
MODES



PRINTING
TECHNIQUES



SUSTAINABILITY



BIC
GRAPHIC

BIC®
WRITING INSTRUMENTS

OTHER WRITING
INSTRUMENTS

NOTEBOOKS

BIC® / DIEEP® LIGHTERS
AND BIC® CASES

BIC®
PACKAGING

GENERAL
INFORMATION

See pages 272-276 for a detailed explanation of the icons.

CLICK PEN

11748

CLICK PEN

11748

Colour ink



01



03



04



05



02



10

1:1 scale

CLICK PEN

11748

CLICK PEN

11748

A/B SP: max. 4 col.
C/D PD: max. 4 col.

MOQ 500 units

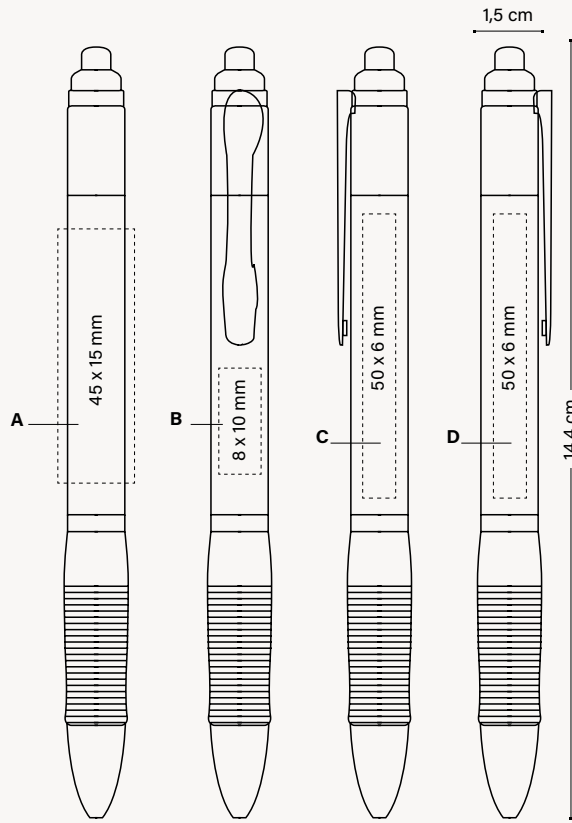

EXTERNAL PACKAGING



1000 ± 9,5 KG



WRITING MODES



PRINTING TECHNIQUES



SUSTAINABILITY



BIC®
GRAPHIC

BIC®
WRITING INSTRUMENTS

OTHER WRITING
INSTRUMENTS

NOTEBOOKS

BIC® / DIEEP® LIGHTERS
AND BIC® CASES

BIC®
PACKAGING

GENERAL
INFORMATION

See pages 272-276 for a detailed explanation of the icons.

STRIPED GRIP PEN

11243

STRIPED GRIP PEN

11243

Colour ink
●



10



03



24



8C



04

1:1 scale

STRIPED GRIP PEN

11243

STRIPED GRIP PEN

11243

A SP: max. 2 col.

B PD: max. 1 col.

MOQ 500 units

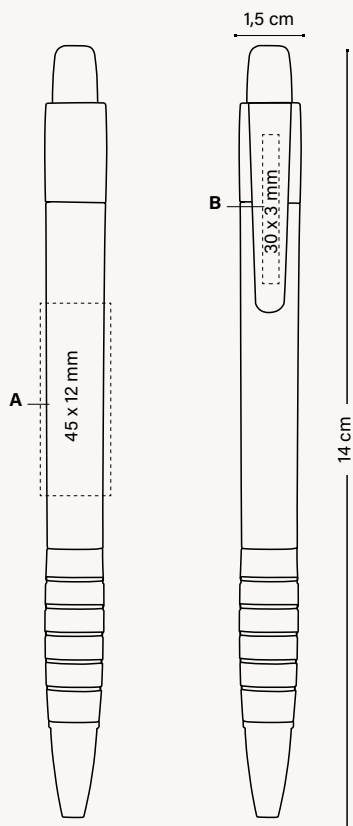

EXTERNAL PACKAGING



WRITING MODES



PRINTING TECHNIQUES



SUSTAINABILITY



BIC®
GRAPHIC

BIC®
WRITING INSTRUMENTS

OTHER WRITING
INSTRUMENTS

NOTEBOOKS

BIC® / DIEEP® LIGHTERS
AND BIC® CASES

BIC®
PACKAGING

GENERAL
INFORMATION

See pages 272-276 for a detailed explanation of the icons.

SLEEK STYLUS PEN

A pen for every professional moment.

Confident writing for every signature..

FR/

Un stylo pour chaque moment professionnel.

Une écriture assurée pour chaque signature.

DE/

Ein Stift für jeden professionellen Moment.

Sicheres Schreiben für jede Unterschrift.

IT/

Una penna per ogni momento professionale.

Scrittura sicura per ogni firma.

ES/

Un bolígrafo para cada momento profesional.

Escritura segura para cada firma.

SLEEK STYLUS PEN FAMILY



11666
Sleek Stylus Pen



11747
Sleek Stylus
Matt Pen



11976
Sleek Stylus
Executive Pen

Write Boldly



SLEEK STYLUS PEN

11666

SLEEK STYLUS PEN

11666

Colour ink



01

11747

SLEEK STYLUS MATT PEN

11747

Colour ink



47



04

11976

SLEEK STYLUS EXECUTIVE PEN

11976



26

Available in blue ink



2N

Available in black ink

SLEEK STYLUS PEN

11666 / 11747 / 11976

SLEEK STYLUS PEN

11666

SLEEK STYLUS MATT PEN

11747

SLEEK STYLUS EXECUTIVE PEN

11976

A SP: max. 1 col.

B SP: max. 2 col.

C LE

MOQ 500 units (SP)

MOQ 100 units (LE)

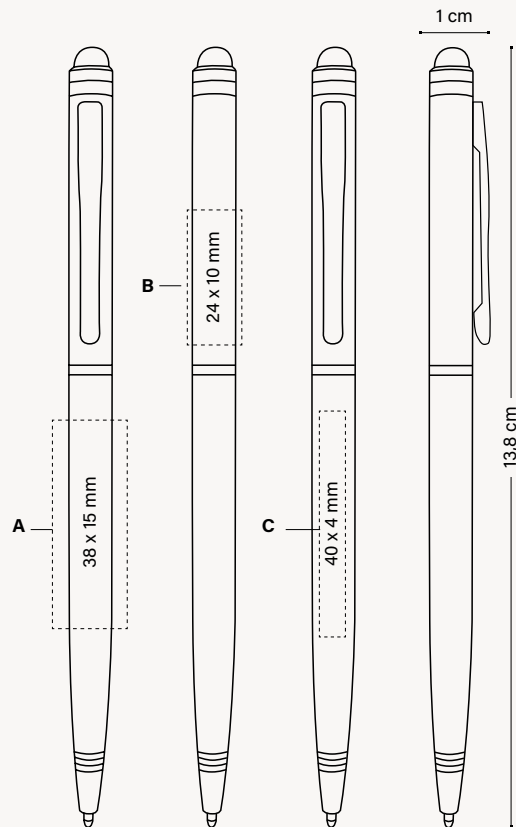

EXTERNAL PACKAGING



(11666)
900 ± 12,4 KG



(11747 / 11976)
800 ± 13 KG



WRITING MODES



PRINTING TECHNIQUES



SUSTAINABILITY



BIC® GRAPHIC

BIC® WRITING INSTRUMENTS

OTHER WRITING INSTRUMENTS

NOTEBOOKS

BIC® / DIEEP® LIGHTERS AND BIC® CASES

BIC® PACKAGING

GENERAL INFORMATION

See pages 272-276 for a detailed explanation of the icons.

NOTEBOOKS

03

BIC® PARTNER NOTEBOOKS



BIC® PARTNER: a high-quality,
Made in Italy notebook that goes
wherever your ideas take you.

FR/
BIC® PARTNER : un carnet de haute qualité, fabriqué en
Italie, qui vous accompagne partout où vos idées vous
mènent.

DE/
BIC® PARTNER: ein hochwertiges Notizbuch, hergestellt
in Italien, das Sie überall hin begleitet, wohin Ihre Ideen
Sie führen.

IT/
BIC® PARTNER: un taccuino di alta qualità, prodotto in
Italia, che ti accompagna ovunque ti portino le tue idee.

ES/
BIC® PARTNER: una libreta de alta calidad, fabricada en
Italia, que te acompaña allí donde te lleven tus ideas.

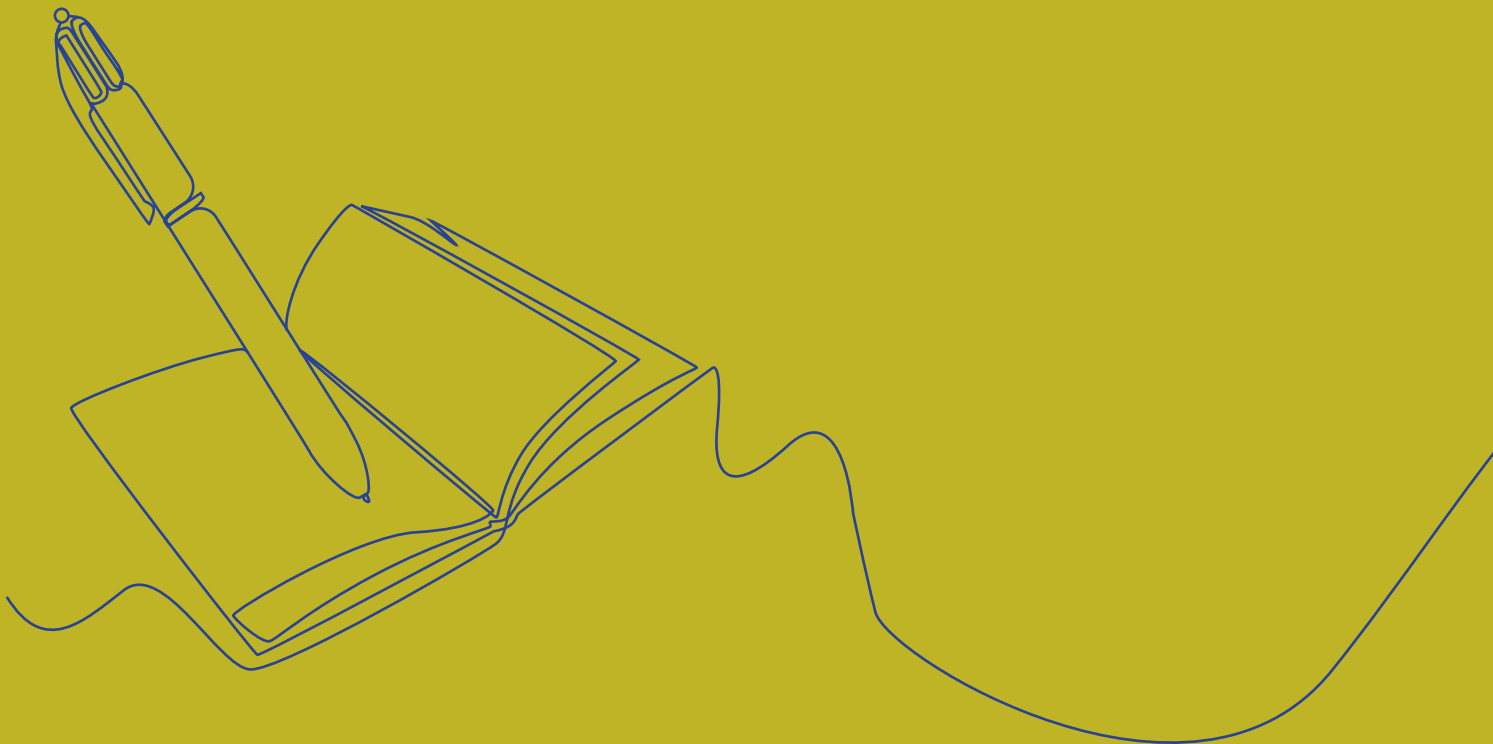

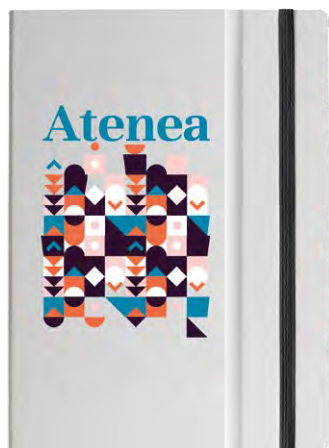

3709
BIC® Partner Hard Cover*

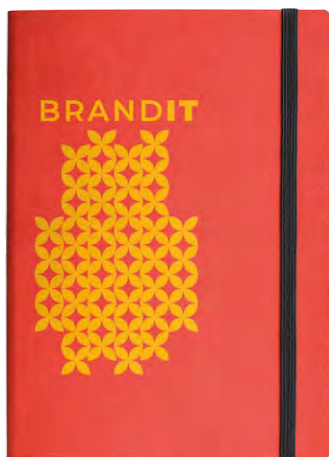

3710
BIC® Partner Flex Cover*



3711
BIC® Partner FruitCover*

* Pen not included.
FR/ * Stylo non inclus. DE/ * Stift nicht enthalten. IT/ * Penna non inclusa. ES/ * Bolígrafo no incluido.

3709

BIC® PARTNER HARD COVER
3709

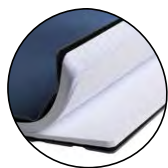

Equipped with our **Quickview system** that allows for easy consultation.

FR/ Équipé d'un système Quickview permettant une consultation facile.

DE/ Ausgestattet mit einem Quickview-System, das eine einfache Einsicht ermöglicht.

IT/ Dotato del sistema Quickview che permette una consultazione semplice.

ES/ Equipada con el sistema Quickview que permite una fácil consulta.

DIN A5

72 sheets / 144 pages



01
White



02
Black



07
Blue Navy



03
Red



High-quality, recycled, FSC-certified paper

FR/ Papier de haute qualité, recyclé et certifié FSC.
DE/ Hochwertiges, recyceltes, FSC-zertifiziertes Papier.
IT/ Carta di alta qualità, riciclata e certificata FSC.
ES/ Papel de alta calidad, reciclado y certificado por el FSC.



Elastic closure

FR/ Fermeture élastique.
DE/ Elastischer Verschluss.
IT/ Chiusura elastica.
ES/ Cierre elástico.



Internal pocket

FR/ Poche intérieure.
DE/ Innentasche.
IT/ Tasca interna.
ES/ Bolsillo interior.

Pen not included

FR/ Stylo non inclus.

DE/ Stift nicht enthalten.

IT/ Penna non inclusa.

ES/ Bolígrafo no incluido.

BIC® PARTNER HARD COVER

3709

BIC® PARTNER HARD COVER

3709

A SP: max. 1 col.





B BP: full-colour

C/D HS/DB: max. 1 col.

MOQ 25 units

BIC® Partner Hard Cover contain FSC Certified White Paper, 80 g/m², with no artificial coating, made from eucalyptus cellulose, short fibre, with an excellent wrapping and high whiteness.

 LINED PAPER

 Black  Blue  White  Red

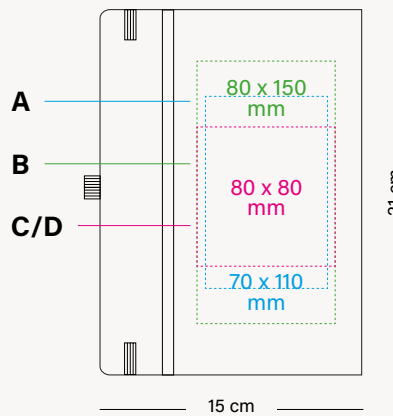
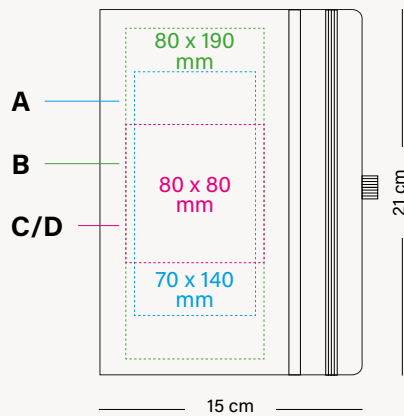

EXTERNAL PACKAGING



25 ± 9,7 KG

FR/ BIC® Partner Hard Cover contient du papier blanc certifié FSC, 80 g/m², sans revêtement artificiel, fabriqué à partir de cellulose d'eucalyptus à fibres courtes et d'une très haute blancheur.

DE/ BIC® Partner Hard Cover enthält FSC-zertifiziertes weißes Papier, 80 g/m², ohne künstliche Beschichtung, hergestellt aus Eukalyptuszellstoff, Kurzfaser, mit hohem Weißgrad.

IT/ BIC® Partner Hard Cover contiene carta bianca certificata FSC, 80 g/m², senza rivestimento artificiale, realizzata in cellulosa di eucalipto, fibra corta, con elevato grado di bianco.

ES/ BIC® Partner Hard Cover contiene papel blanco certificado FSC, de 80 g/m², sin recubrimiento artificial, fabricado con celulosa de eucalipto, de fibra corta y alta blancura.



Pen Holder

FR/ Porte-stylo.
DE/ Stifthalter.
IT/ Portapenna.
ES/ Portabolígrafos.



If found, please

"If found, please return to" printed on the 1st page

FR/ "En cas de perte, veuillez retourner à" imprimé en anglais sur la 1ère page.
DE/ „Wenn gefunden, bitte zurückgeben an" auf der ersten Seite auf Englisch gedruckt.
IT/ "Se trovato, per favore restituire a" stampato in inglese sulla prima pagina.
ES/ "Si lo encuentra, devuélvalo a" impreso en inglés en la primera página.



Descriptive Leaflet

FR/ Brochure descriptive.
DE/ Beschreibende Broschüre.
IT/ Opuscolo descrittivo.
ES/ Folleto descriptivo.



PRINTING TECHNIQUES



SUSTAINABILITY



FSC AND RECYCLABLE CARDBOARD

BIC GRAPHIC

BIC® WRITING INSTRUMENTS

OTHER WRITING INSTRUMENTS

NOTEBOOKS

BIC® / DIEEP® LIGHTERS AND BIC® CASES

BIC® PACKAGING

GENERAL INFORMATION

See pages 272-276 for a detailed explanation of the icons.

BIC® PARTNER FLEX COVER



3710

BIC® PARTNER FLEX COVER
3710



Featuring a **soft-touch finish.**

FR/ Finition Soft-Touch
au toucher.

DE/ Ausgestattet mit einer
Soft-Touch-Oberfläche.

IT/ Caratterizzato da una
finitura Soft-Touch al tatto.

ES/ Con un acabado
Soft-Touch al tacto.

DIN A5
72 sheets / 144 pages



02
Black



03
Red



07
Navy Blue



**High-quality, recycled,
FSC-certified paper**

FR/ Papier de haute qualité, recyclé et certifié FSC.
DE/ Hochwertiges, recyceltes, FSC-zertifiziertes Papier.
IT/ Carta di alta qualità, riciclata e certificata FSC.
ES/ Papel de alta calidad, reciclado y certificado por el FSC.



**Elastic
closure**

FR/ Fermeture élastique.
DE/ Elastischer Verschluss.
IT/ Chiusura elastica.
ES/ Cierre elástico.



**Internal
pocket**

FR/ Poche intérieure.
DE/ Innentasche.
IT/ Tasca interna.
ES/ Bolsillo interior.

Pen not included

FR/ Stylo non inclus.

DE/ Stift nicht enthalten.

IT/ Penna non inclusa.

ES/ Bolígrafo no incluido.

BIC® PARTNER FLEX COVER

3710

BIC® PARTNER FLEX COVER

3710

A SP: max. 1 col.

B HS: max. 1 col.

C DB: max. 1 col.

MOQ 25 units

BIC® Partner Flex Cover contain FSC Certified White Paper, 80 g/m², with no artificial coating, made from eucalyptus cellulose, short fibre, with an excellent wrapping and high whiteness.



LINED PAPER

● Black ● Blue ● Red

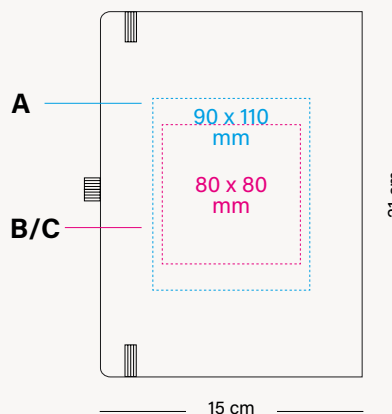
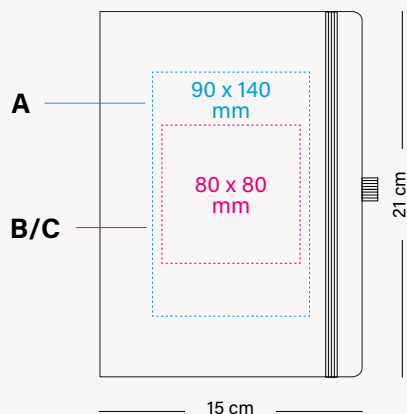

EXTERNAL PACKAGING



FR/ BIC® Partner Flex Cover contient du papier blanc certifié FSC, 80 g/m², sans revêtement artificiel, fabriqué à partir de cellulose d'eucalyptus, fibres courtes, d'une très haute blancheur.

DE/ BIC® Partner Flex Cover enthalten FSC-zertifiziertes weißes Papier, 80 g/m², ohne künstliche Beschichtung, hergestellt aus Eukalyptuszellstoff, Kurzfasern, mit hohem Weißgrad.

IT/ BIC® Partner Flex Cover contengono carta bianca certificata FSC, 80 g/m², senza rivestimento artificiale, realizzata in cellulosa di eucalipto, fibra corta, con elevato grado di bianco.

ES/ BIC® Partner Flex Cover contiene papel blanco certificado FSC, de 80 g/m², sin recubrimiento artificial, fabricado con celulosa de eucalipto, de fibra corta y alta blancura.



Pen Holder

FR/ Porte-stylo.
DE/ Stifthalter.
IT/ Portapenna.
ES/ Portabolígrafos.



"If found, please return to" printed on the 1st page

FR/ "En cas de perte, veuillez retourner à" imprimé en anglais sur la 1ère page.
DE/ „Wenn gefunden, bitte zurückgeben an" auf der ersten Seite auf Englisch gedruckt.
IT/ "Se trovato, per favore restituire a" stampato in inglese sulla prima pagina.
ES/ "Si lo encuentra, devuélvalo a" impreso en inglés en la primera página.



Descriptive Leaflet

FR/ Brochure descriptive.
DE/ Beschreibende Broschüre.
IT/ Opuscolo descrittivo.
ES/ Folleto descriptivo.



PRINTING TECHNIQUES



SCREEN PRINTING



HOT STAMPING



DEBOSSING

SUSTAINABILITY



FSC AND RECYCLABLE CARDBOARD

BIC® GRAPHIC

BIC® WRITING INSTRUMENTS

OTHER WRITING INSTRUMENTS

NOTEBOOKS

BIC® / DIEEP® LIGHTERS AND BIC® CASES

BIC® PACKAGING

GENERAL INFORMATION

See pages 272-276 for a detailed explanation of the icons.

3711

BIC® PARTNER FRUITCOVER

3711

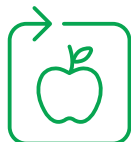

The cover is made from 39% apple waste.

FR/ La couverture est fabriquée à partir de 39% de déchets de pommes.

DE/ Die Hülle besteht zu 39% aus Apfelabfällen.

IT/ La copertina è realizzata per il 39% con scarti di mele.

ES/ La cubierta está fabricada con un 39% de residuos de manzana.

DIN A5
72 sheets / 144 pages



10
Yellow Sand



59
Green Apple



06
Grey Stone



**High-quality, recycled,
FSC-certified paper**

FR/ Papier de haute qualité, recyclé et certifié FSC.
DE/ Hochwertiges, recyceltes, FSC-zertifiziertes Papier.
IT/ Carta di alta qualità, riciclata e certificata FSC.
ES/ Papel de alta calidad, reciclado y certificado por el FSC.



**Elastic
closure**

FR/ Fermeture élastique.
DE/ Elastischer Verschluss.
IT/ Chiusura elastica.
ES/ Cierre elástico.



**Internal
pocket**

FR/ Poche intérieure.
DE/ Innentasche.
IT/ Tasca interna.
ES/ Bolsillo interior.

Pen not included

FR/ Stylo non inclus.

DE/ Stift nicht enthalten.

IT/ Penna non inclusa.

ES/ Bolígrafo no incluido.

BIC® PARTNER FRUITCOVER

3711

BIC® PARTNER FRUITCOVER

3711

A SP: max. 1 col.

B HS: max. 1 col.

C DB: max. 1 col.

MOQ 25 units

BIC® Partner FruitCover contains Recycled FSC Certified Ivory Paper, 80 g/m².



LINED PAPER



Green Apple



Grey Stone



Yellow Sand

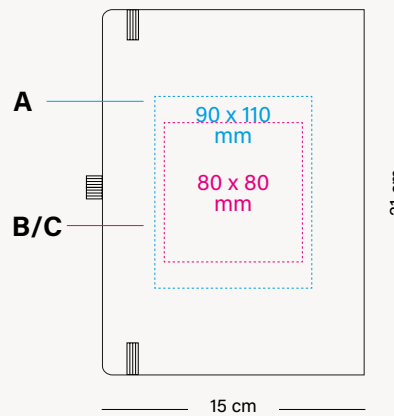
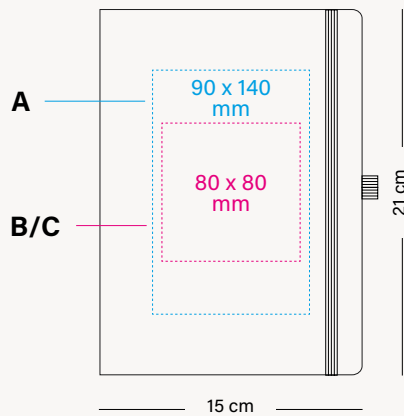

EXTERNAL PACKAGING



FR/ BIC® Partner FruitCover contient du papier recyclé de couleur ivoire, avec certification FSC, 80 g/m².

DE/ BIC® Partner FruitCover enthält recyceltes Papier in Elfenbeinfarbe, mit FSC-Zertifizierung, 80 g/m².

IT/ BIC® Partner FruitCover contiene carta riciclata di colore avorio, con certificazione FSC, 80 g/m².

ES/ BIC® Partner FruitCover contiene papel de color marfil reciclado, con certificación FSC, 80 g/m².



Pen Holder

FR/ Porte-stylo.
DE/ Stifthalter.
IT/ Portapenna.
ES/ Portabolígrafos.



If found, please

"If found, please return to" printed on the 1st page

FR/ "En cas de perte, veuillez retourner à" imprimé en anglais sur la 1ère page.
DE/ „Wenn gefunden, bitte zurückgeben an" auf der ersten Seite auf Englisch gedruckt.
IT/ "Se trovato, per favore restituire a" stampato in inglese sulla prima pagina.
ES/ "Si lo encuentra, devuélvalo a" impreso en inglés en la primera página.



Descriptive Leaflet

FR/ Brochure descriptive.
DE/ Beschreibende Broschüre.
IT/ Opuscolo descrittivo.
ES/ Folleto descriptivo.



PRINTING TECHNIQUES



SCREEN PRINTING



HOT STAMPING



DEBOSSING

SUSTAINABILITY



FSC AND RECYCLABLE CARDBOARD

BIC® GRAPHIC

BIC® WRITING INSTRUMENTS

OTHER WRITING INSTRUMENTS

NOTEBOOKS

BIC® / DIEEP® LIGHTERS AND BIC® CASES

BIC® PACKAGING

GENERAL INFORMATION

See pages 272-276 for a detailed explanation of the icons.

BIC® PARTNER NOTEBOOKS

Personalise your perfect BIC® Partner Notebook
with our NEW TAILORMADE SERVICE



**Choose your colour,
even Pantone!**

Available with:

BIC® Partner Hard Cover

**Digital Art Paper, cover fully printed
on front and back, on 100% of surface.**

Available with:

BIC® Partner Hard Cover

**Personalise
internal pages**

Available with:

BIC® Partner Hard Cover

BIC® Partner Flex Cover

BIC® Partner Fruitcover



Made
in Italy



Contact your sales representative for more information

FR/

**Personnalisez votre carnet BIC® Partner avec
notre NOUVEAU SERVICE SUR MESURE**

- Choisissez votre couleur —même le Pantone !
- Digital Art Paper, couverture entièrement imprimée à l'avant et à l'arrière, sur 100 % de la surface.
- Personnalisez les pages intérieures.

* *Contactez votre représentant commercial pour plus d'informations.*

DE/

**Personalisieren Sie Ihr perfektes BIC® Partner Notebook
mit unserem NEUEN MASSGESCHNEIDERTEN SERVICE**

- Wählen Sie Ihre Farbe - sogar Pantone!
- Digital Art Paper, Umschlag vollständig vorne und hinten bedruckt, auf 100 % der Oberfläche.
- Individualisieren Sie die Innenseiten.

* *Wenden Sie sich an Ihren Vertriebsmitarbeiter, um weitere Informationen zu erhalten.*



BIC GRAPHIC

BIC® WRITING INSTRUMENTS

OTHER WRITING INSTRUMENTS

NOTEBOOKS

BIC® / DIEEP® LIGHTERS AND BIC® CASES

BIC® PACKAGING

GENERAL INFORMATION

Contact your sales representative for more information

IT/
Personalizza il tuo taccuino BIC® Partner perfetto con il nostro NUOVO SERVIZIO SU MISURA

- Scegli colore—anche Pantone!
- Digital Art Paper, copertina completamente stampata davanti e dietro sul 100% della superficie.
- Personalizza le pagine interne.

* Contatta il tuo rappresentante commerciale per maggiori informazioni.

ES/
Personaliza tu libreta BIC® Partner perfecta con nuestro NUEVO SERVICIO A MEDIDA

- Elige tu color—¡Incluso Pantone!
- Digital Art Paper, cubierta completamente impresa por delante y por detrás, en el 100% de la superficie.
- Personaliza las páginas interiores.

*Contacta a tu representante de ventas para más información.

**BIC® / DJEEP®
LIGHTERS AND
BIC® CASES**

04

BIC® LIGHTERS

The iconic, well-loved and time-honoured shapes of BIC® lighters remain on trend!

Five different models and a wide range of colour combinations.

FR/

Le célèbre briquet BIC®, une icône indémodable, avec un design toujours tendance !

Cinq modèles différents et une large gamme de combinaisons de couleurs.

DE/

Das legendäre, beliebte und bewährte Design des BIC®-Feuerzeugs liegt weiter im Trend!

Fünf verschiedene Modelle und eine große Auswahl an Farbkombinationen.

IT/

L'iconico, amato e intramontabile design dell'accendino BIC® resta di tendenza!

Cinque modelli diversi e un'ampia gamma di combinazioni di colori.

ES/

¡El diseño icónico, querido y atemporal del encendedor BIC® sigue siendo tendencia!

Cinco modelos diferentes y una amplia gama de combinaciones de colores.

Light up



BIC® LIGHTERS FAMILY

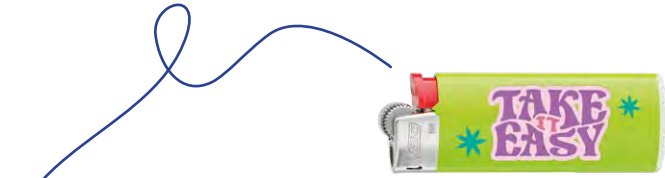

2360
BIC® J25 Lighter
Screen Printing



2360
BIC® J25 Lighter
Digital Printing



2340
BIC® J23 Lighter
Screen Printing



2340
BIC® J23 Lighter
Digital Printing



2320
BIC® J26 Lighter
Screen Printing



2320
BIC® J26 Lighter
Digital Printing



2452
BIC® J38 Lighter
Screen Printing



2452
BIC® J38 Lighter
Digital Printing



2450
BIC® EZ Reach™ Lighter
Screen Printing



2450
BIC® EZ Reach™ Lighter
Digital Printing

BIC
GRAPHIC

BIC®
WRITING INSTRUMENTS

OTHER WRITING
INSTRUMENTS

NOTEBOOKS

BIC® / DJEEP® LIGHTERS
AND BIC® CASES

BIC®
PACKAGING

GENERAL
INFORMATION

BIC® lighters. Our quality, your safety.

All BIC® lighters meet or exceed international standards and regulations requirements (ISO 9994, EN 13869, ASTM F400, US CPSC).
Don't risk it, buy a BIC® lighter!



BIC® is number one worldwide for branded lighters.*



100 % of BIC® Lighters sold by BIC Graphic Europe are manufactured by BIC in Europe. All BIC® Lighters are made in BIC factories. This is the starting block of the BIC® lighter safety guarantee.

50 YEARS

BIC has acquired 50 years of incredible manufacturing expertise to guarantee the safety and quality of its products.

50 CHECKS

Before leaving the factory, every BIC® Lighter undergoes more than 50 automatic quality and security checks.

FR /

BIC® est le numéro un mondial des briquets de marque.

100 % des briquets BIC® vendus par BIC Graphic Europe sont fabriqués par BIC en Europe.

BIC a acquis 50 ans d'une incroyable expertise de fabrication afin de garantir la sécurité et la qualité de ses produits.

Avant de quitter l'usine, chaque briquet BIC® subit plus de 50 contrôles automatiques de qualité et de sécurité.

DE /

BIC® ist weltweit die Nummer eins bei Markenfeuerzeugen.

100 % der von BIC Graphic Europe verkauften BIC®-Feuerzeuge werden von BIC in Europa hergestellt.

BIC hat in 50 Jahren eine unglaubliche Fertigungskompetenz erworben und kann somit die Sicherheit und Qualität seiner Produkte gewährleisten.

Jedes BIC® Feuerzeug durchläuft vor Verlassen des Werks über 50 automatische Qualitäts- und Sicherheitskontrollen.

IT /

BIC® è il numero uno al mondo fra gli accendini di marca.

Il 100% degli accendini BIC® venduti da BIC Graphic Europe è prodotto da BIC in Europa.

BIC® ha acquisito 50 anni di incredibile esperienza di produzione per garantire la sicurezza e la qualità dei propri prodotti.

Prima di lasciare la fabbrica, ogni accendino BIC® viene sottoposto a oltre 50 controlli automatici di qualità e sicurezza.

ES /

BIC® es el número uno mundial en encendedores de marca.

El 100 % de los encendedores BIC® vendidos por BIC Graphic Europe son fabricados por BIC en Europa.

Durante 50 años BIC ha adquirido increíbles conocimientos de fabricación para garantizar la seguridad y calidad de sus productos.

Antes de salir de fábrica, cada encendedor BIC® se somete a más de 50 controles automáticos de calidad y seguridad.



With more than 50 years of experience as a guarantee!



Screen printing

Perfect technique for creating high-quality prints and exact colour matches.



Brilliant

Choose the brilliant finish for a dazzling final effect.



Matt

Use the matt finish to add a touch of elegance to your design.



Metallic

Create great effects! Metallic effects in text, images and backgrounds.

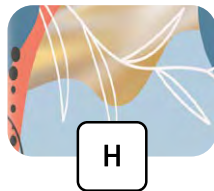

Holographic

Stand out from the crowd! Play with gold or silver reflections in your design.



Puffy

Highlighted personalisation that gives a relief effect to your logo.



Puffy Glitter

Embellish your designs with the shimmering effect of glitter. See and feel its coloured glitter texture.



UV

Highlight your brand with a high-gloss finish! Combine a matt and gloss finish to highlight contrasts.

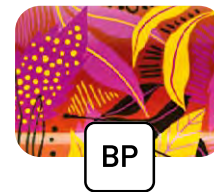

BritePix™ Digital

The solution for full-colour communication. Now on coloured barrels!



BIC® Lighters finishes

Perfect for your pocket!

2360 / 2364

BIC® J25 LIGHTER
2360
2364 All Black



Iconic BIC® Boy
and BIC® logo
engraved!



01

57

57

8G

03

11

59

24



25

25

6W

02

02

02

02

1:1 scale

FR /
**Parfait pour
votre poche !**

DE /
**Passt perfekt in
die Hosentasche!**

IT /
**Perfetto per
le tue tasche!**

ES /
**¡Perfecto para
tu bolsillo!**

BIC® J25 LIGHTER

2360/2364

BIC® J25 LIGHTER

2360/2364

A/C SP: max. 4 col.

MOQ 300 units

2360/2364

BIC® J25 LIGHTER BRITEPIX™

2360 / 2364

A/C BP: full-colour

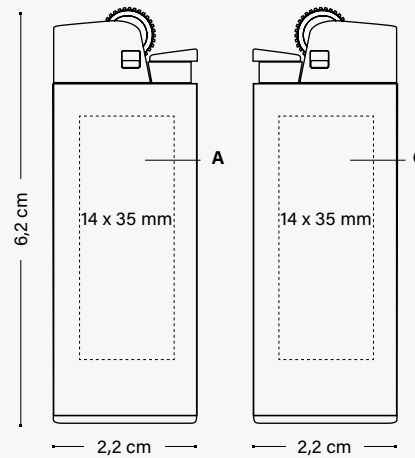
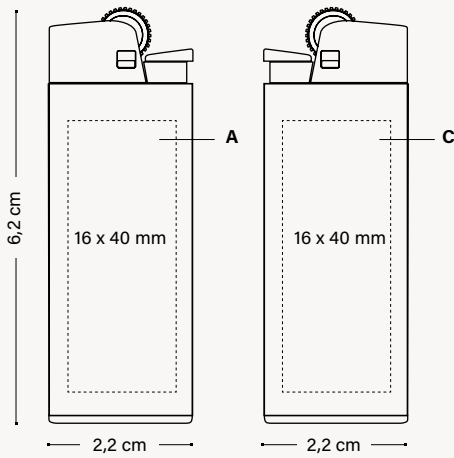

PACKAGING



100% recycled!

STANDARD PACKAGING:
IN TRAY OF 50 UNITS

EXTERNAL PACKAGING



600 ± 76 KG



FSC AND
RECYCLABLE
CARDBOARD

OPTIONAL INNER PACKAGING

0087

COUNT BOX 10 UNITS CASES



0088

COUNT BOX 10 UNITS
CASES CHILD RESISTANT



0086

COUNT BOX 10 UNITS
J25 CHILD RESISTANT



PRINTING
TECHNIQUES



SUSTAINABILITY



100% ELECTRICITY
COMING FROM
RENEWABLE SOURCES



Check out
the video

BIC
GRAPHIC

BIC®
WRITING INSTRUMENTS

OTHER WRITING
INSTRUMENTS

NOTEBOOKS

BIC® / DJEEP® LIGHTERS
AND BIC® CASES

BIC®
PACKAGING

GENERAL
INFORMATION

See pages 272-276 for a detailed explanation of the icons.

DIGITAL FINISHES



BR BRILLIANT



MT MATT

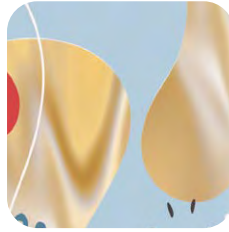

H HOLOGRAPHIC SILVER GOLD



P PUFFY



M METALLIC



UV UV



PG PUFFY GLITTER

2360

BIC® J25 LIGHTER
2360



MT MATT

P PUFFY



PG PUFFY GLITTER



MT MATT

M METALLIC

360° Printing

1:1 scale

BIC® J25 LIGHTER

2360

BIC® J25 LIGHTER

2360

A DG: full-colour

MOQ 600 units

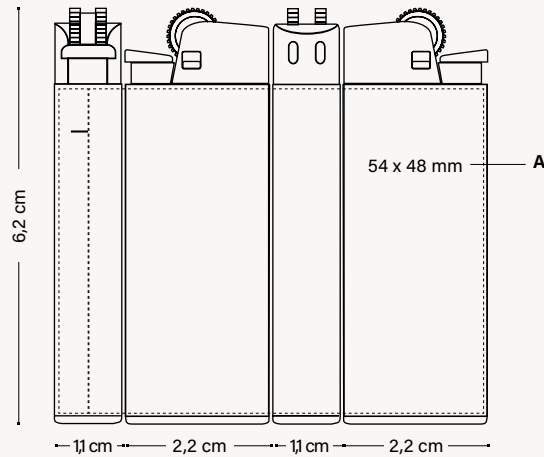

PRINTING TECHNIQUES



SUSTAINABILITY



PACKAGING



100% recycled!

STANDARD PACKAGING:
IN TRAY OF 50 UNITS

EXTERNAL PACKAGING



600 ± 76 KG



FSC AND
RECYCLABLE
CARDBOARD

OPTIONAL INNER PACKAGING

0087

COUNT BOX 10 UNITS CASES



0088

COUNT BOX 10 UNITS
CASES CHILD RESISTANT



0086

COUNT BOX 10 UNITS
J25 CHILD RESISTANT



Check out
the video

See pages 272-276 for a detailed explanation of the icons.

BIC® J23 LIGHTER



Iconic BIC® Boy
and BIC® logo
engraved!

2340

BIC® J23 LIGHTER
2340



57



12



03



10

*Slim and fits
everywhere!*



1:1 scale



05



04



25



02

BIC® J23 LIGHTER

2340

BIC® J23 LIGHTER

2340

A/C SP: max. 4 col.

MOQ 300 units

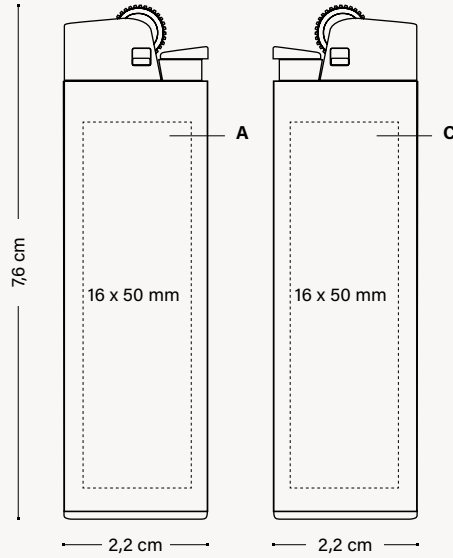

PACKAGING



100% recycled!

STANDARD PACKAGING:
IN TRAY OF 50 UNITS

EXTERNAL PACKAGING



600 ± 9,5 KG



FSC AND
RECYCLABLE
CARDBOARD

OPTIONAL INNER PACKAGING

0087

COUNT BOX 10 UNITS CASES



0088

COUNT BOX 10 UNITS
CASES CHILD RESISTANT



PRINTING
TECHNIQUES



SUSTAINABILITY



Check out
the video

See pages 272-276 for a detailed explanation of the icons.

DIGITAL FINISHES



BR BRILLIANT



MT MATT

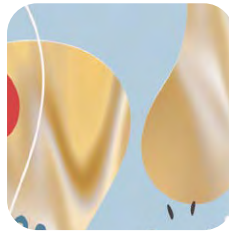

H HOLOGRAPHIC SILVER GOLD



P PUFFY



M METALLIC



UV UV



PG PUFFY GLITTER

2340

BIC® J23 LIGHTER
2340



MT MATT



PG PUFFY GLITTER



BR BRILLIANT

H HOLOGRAPHIC GOLD

1:1 scale

BIC® J23 LIGHTER

2340

BIC® J23 LIGHTER

2340

A DG: full-colour

MOQ 600 units

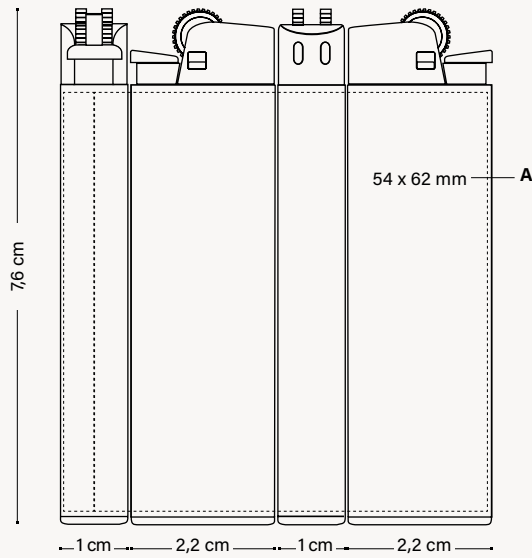

PACKAGING



100% recycled!

STANDARD PACKAGING:
IN TRAY OF 50 UNITS

EXTERNAL PACKAGING



600 ± 9,5 KG



FSC AND
RECYCLABLE
CARDBOARD

OPTIONAL INNER PACKAGING

0087

COUNT BOX 10 UNITS CASES



0088

COUNT BOX 10 UNITS
CASES CHILD RESISTANT



PRINTING
TECHNIQUES



Check out
the video

See pages 272-276 for a detailed explanation of the icons.

The flame that lasts.



Iconic BIC® Boy and BIC® logo engraved!

2320

BIC® J26 LIGHTER
2320



01



57



8G



10B



6W

Extra long-lasting: up to 3.000 lights!



1:1 scale



59



24



25



02



03

FR /
**La flamme
qui dure.**

DE /
**Die Flamme,
die anhält.**

IT /
**La fiamma
che dura.**

ES /
**La llama
que dura.**

BIC® J26 LIGHTER

2320

BIC® J26 LIGHTER

2320

A/C SP: max. 4 col.

MOQ 300 units

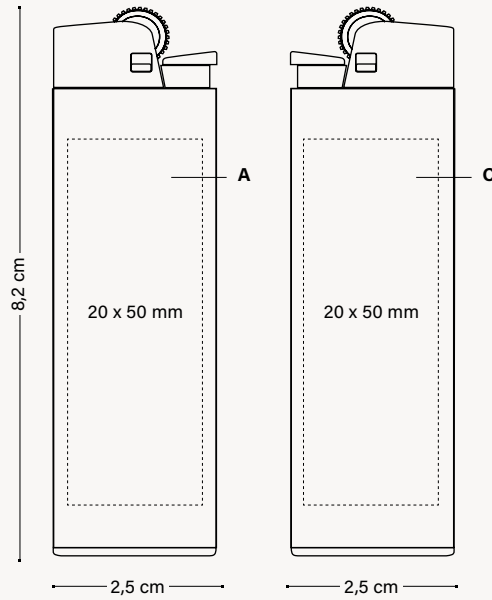

PACKAGING



100% recycled!

STANDARD PACKAGING:
IN TRAY OF 50 UNITS

EXTERNAL PACKAGING



600 ± 15,1 KG



FSC AND
RECYCLABLE
CARDBOARD

OPTIONAL INNER PACKAGING

0087

COUNT BOX 10 UNITS CASES



0088

COUNT BOX 10 UNITS
CASES CHILD RESISTANT



PRINTING
TECHNIQUES



SUSTAINABILITY



Check out
the video

See pages 272-276 for a detailed explanation of the icons.

DIGITAL FINISHES



BR BRILLIANT



MT MATT

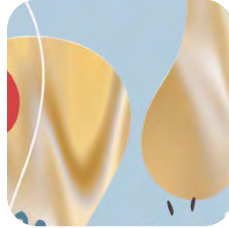

H HOLOGRAPHIC SILVER GOLD



P PUFFY



M METALLIC



UV UV



PG PUFFY GLITTER

2320

BIC® J26 LIGHTER
2320



MT MATT



BR BRILLIANT



MT MATT

360°
Printing

1:1 scale

H HOLOGRAPHIC SILVER

BIC® J26 LIGHTER

2320

BIC® J26 LIGHTER

2320

A DG: full-colour

MOQ 600 units

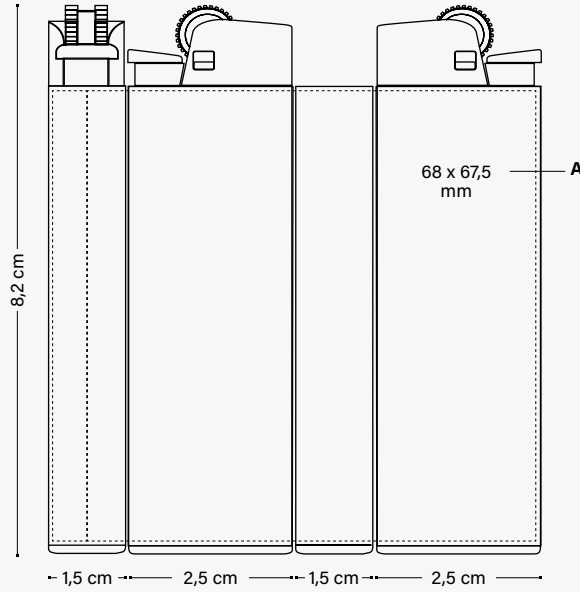

PACKAGING



100% recycled!

STANDARD PACKAGING:
IN TRAY OF 50 UNITS

EXTERNAL PACKAGING



600 ± 15,1 KG



FSC AND RECYCLABLE CARDBOARD

OPTIONAL INNER PACKAGING

0087

COUNT BOX 10 UNITS CASES



0088

COUNT BOX 10 UNITS CASES CHILD RESISTANT



Check out the video

See pages 272-276 for a detailed explanation of the icons.

BIC® J38 LIGHTER

2452



Iconic BIC® Boy and BIC® logo engraved!

BIC® J38 LIGHTER
2452



57



25



02



03



Elegant and comfortable lighting!

1:1 scale

BIC® J38 LIGHTER

2452

BIC® J38 LIGHTER

2452

A/C SP: max. 4 col.

MOQ 300 units

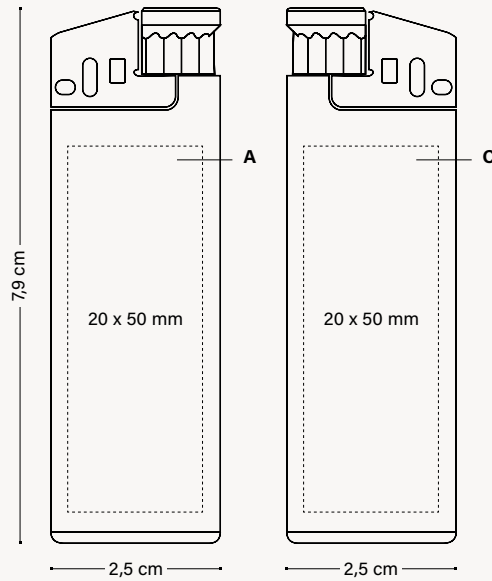

PACKAGING



100% recycled!

STANDARD PACKAGING:
IN TRAY OF 50 UNITS

EXTERNAL PACKAGING



600 ± 13,2 KG



FSC AND
RECYCLABLE
CARDBOARD

OPTIONAL INNER PACKAGING

0087

COUNT BOX 10 UNITS CASES



0088

COUNT BOX 10 UNITS
CASES CHILD RESISTANT



PRINTING
TECHNIQUES



SUSTAINABILITY



Check out
the video

See pages 272-276 for a detailed explanation of the icons.

BIC® J38 LIGHTER

FINISHES



BR BRILLIANT



MT MATT

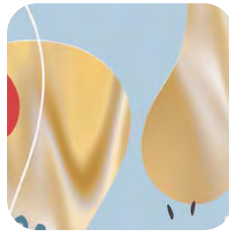

H HOLOGRAPHIC
SILVER
GOLD



P PUFFY



M METALLIC



UV UV



PG PUFFY GLITTER

2452

BIC® J38 LIGHTER
2452



57

BR BRILLIANT



57

MT MATT



57

MT MATT

H HOLOGRAPHIC
GOLD

360°
Printing

1:1 scale

BIC® J38 LIGHTER

2452

BIC® J38 LIGHTER

2452

A DG: full-colour

MOQ 600 units

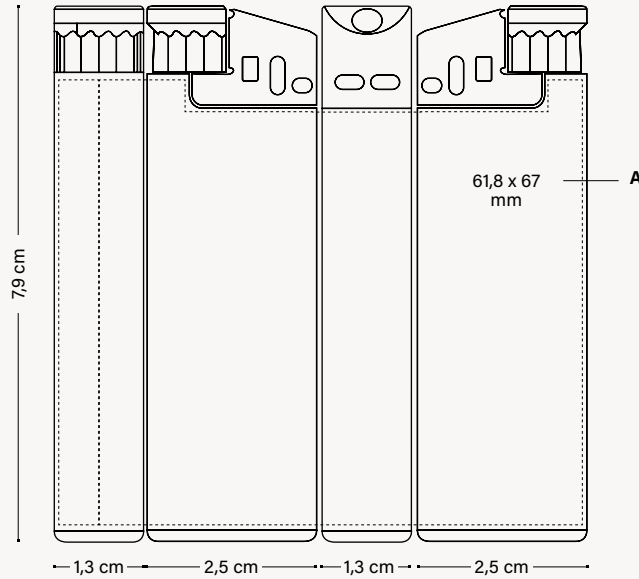

PRINTING TECHNIQUES



SUSTAINABILITY



PACKAGING



100% recycled!

STANDARD PACKAGING:
IN TRAY OF 50 UNITS

EXTERNAL PACKAGING



600 ± 13,2 KG



FSC AND RECYCLABLE CARDBOARD

OPTIONAL INNER PACKAGING

0087

COUNT BOX 10 UNITS CASES



0088

COUNT BOX 10 UNITS CASES CHILD RESISTANT



Check out the video

See pages 272-276 for a detailed explanation of the icons.

SAFETY FLAME

Helps keep fingers away from the flame.



Long lasting with up to 900 flames

Stable flame

thanks to the pure isobutane gas



Convenient format

Easily fits in the pocket



Made in Spain



Convenient for different flame occasions



Safe & Reliable



Keeps fingers away from the flame thanks to its 3.5 cm wand

High force ignition system



Made with 100% electricity coming from renewable sources

High resistance

Made of high mechanical resistance resin Delrin®

FR /
FLAMME SÛRE.
Les doigts restent éloignés de la flamme.

DE /
SICHERHEITS-FLAMME.
Hilft die Finger von der Flamme fernzuhalten.

IT /
FIAMMA SICURA.
Aiuta a tenere le dita lontane dalla fiamma.

ES /
LLAMA SEGURA.
Ayuda a mantener los dedos alejados de la llama.

BIC® EZ REACH™ LIGHTER



2450

BIC® EZ REACH™ LIGHTER
2450

A SP: max. 1 col.
B BP: full-colour

MOQ 300 units

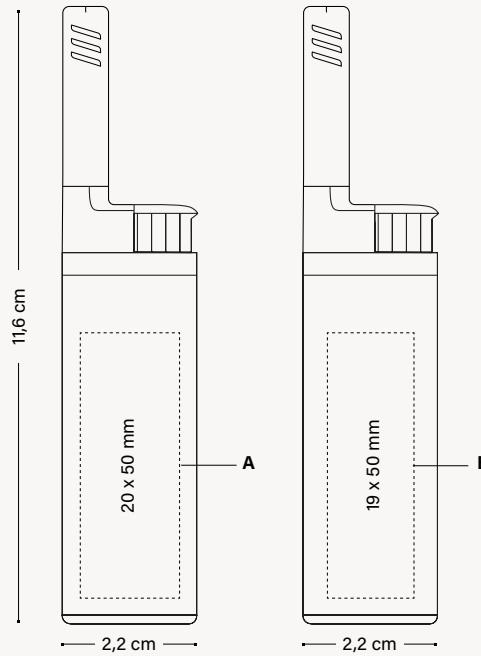

PACKAGING



STANDARD PACKAGING:
IN TRAY OF 50 UNITS

EXTERNAL PACKAGING



150 ± 3.8 KG



FSC AND
RECYCLABLE
CARDBOARD



KEEP FINGERS AWAY
FROM THE FLAME



EASILY FITS
IN THE POCKET

PRINTING TECHNIQUES



SCREEN PRINTING



BRITEPIX™

SUSTAINABILITY



100% ELECTRICITY
COMING FROM
RENEWABLE SOURCES

BIC
GRAPHIC

BIC®
WRITING INSTRUMENTS

OTHER WRITING
INSTRUMENTS

NOTEBOOKS

BIC® / DJEEP® LIGHTERS
AND BIC® CASES

BIC®
PACKAGING

GENERAL
INFORMATION

See pages 272-276 for a detailed explanation of the icons.

BIC® CASES & OTHER BIC® PRODUCTS

Style your lighter with unique, customizable cases! Protect it, personalize it, and stand out.

FR/

Personnalisez votre briquet avec des étuis uniques et personnalisables !

Protégez-le, personnalisez-le et démarquez-vous.

DE/

Gestalten Sie Ihr Feuerzeug mit einzigartigen, individuell anpassbaren Hüllen! Schützen Sie es, personalisieren Sie es und heben Sie sich von der Masse ab.

IT/

Personalizza il tuo accendino con custodie uniche e personalizzabili!

Proteggilo, personalizzalo e distinguiti dalla massa.

ES/

¡Dale estilo a tu encendedor con fundas únicas y personalizables!

Protégelo, personalízalo y destaca entre los demás.

Make it yours



2386
BIC® Styl'it Luxury Case



2156
BIC® Aluminium Flat Case



2398
BIC® Clip Case



2395
BIC® 3D Case



3850
BIC® Pocket Ashtray



3851
BIC® Pocket Ashtray Kraft

BIC
GRAPHIC

BIC®
WRITING INSTRUMENTS

OTHER WRITING
INSTRUMENTS

NOTEBOOKS

BIC® / DJEEP® LIGHTERS
AND BIC® CASES

BIC®
PACKAGING

GENERAL
INFORMATION

BIC® STYL'IT LUXURY CASE

2386

BIC® STYL'IT LUXURY CASE
2386



All cases are delivered with a white BIC® J25 lighter!



59

01

1:1 scale

BIC® STYL'IT LUXURY CASE

2386

BIC® STYL'IT LUXURY CASE
2386

MOQ 100 units
A/C LE

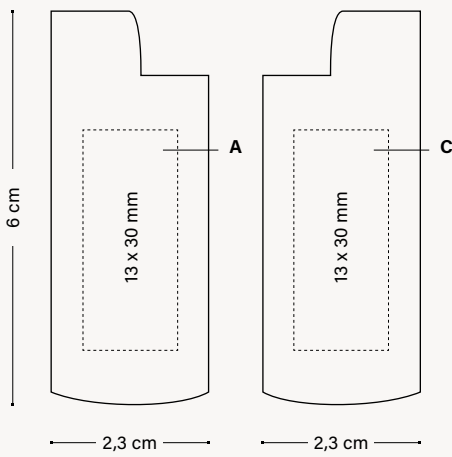

MOQ 100 units
A/C PD

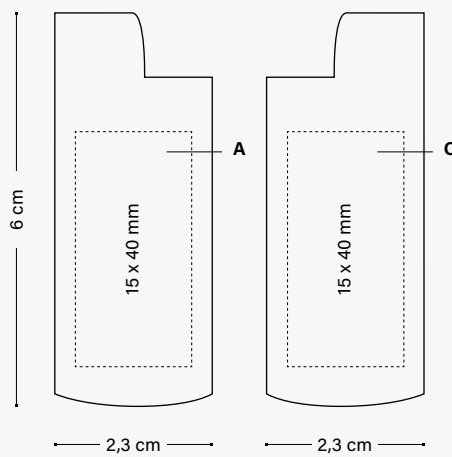

PACKAGING



STANDARD PACKAGING:
BOX FOR 10 UNITS

EXTERNAL PACKAGING



300 ± 6,1 KG



FSC AND
RECYCLABLE
CARDBOARD

OPTIONAL INNER PACKAGING

4551

BOX OF 50 UNITS METAL STYL'IT CASE



PRINTING
TECHNIQUES



SUSTAINABILITY



BIC
GRAPHIC

BIC®
WRITING INSTRUMENTS

OTHER WRITING
INSTRUMENTS

NOTEBOOKS

BIC® / DJEEP® LIGHTERS
AND BIC® CASES

BIC®
PACKAGING

GENERAL
INFORMATION

See pages 272-276 for a detailed explanation of the icons.

BIC® ALUMINIUM FLAT CASE

2156

BIC® ALUMINIUM FLAT CASE
2156

3 customisable sides!



All cases are delivered with a white BIC® J25 lighter!



1:1 scale

47

2156

BIC® ALUMINIUM FLAT CASE
2156

MOQ 100 units
A/C PD: max. 1 col.

MOQ 100 units
A/B/C BP: full-colour

MOQ 100 units
A/B/C LE

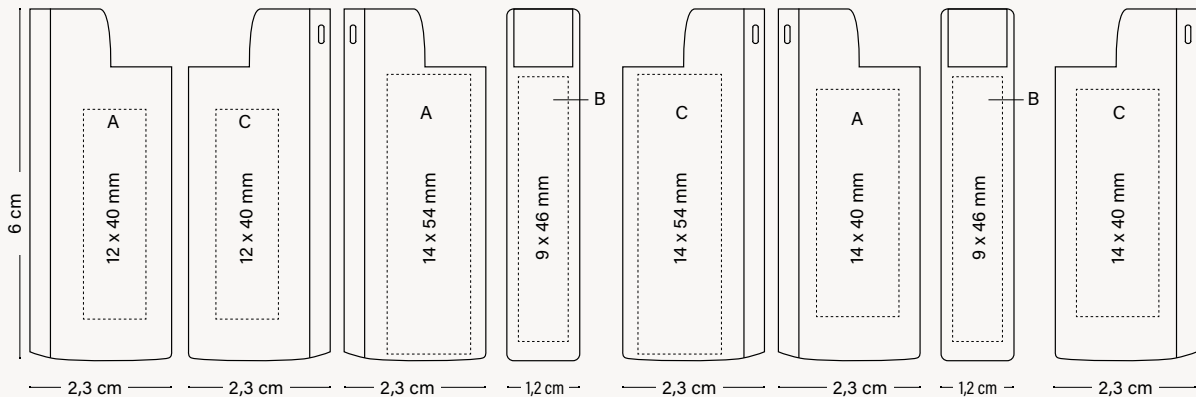

PACKAGING



STANDARD PACKAGING:
BOX FOR 50 UNITS

EXTERNAL PACKAGING



300 ± 7,5 KG



FSC AND
RECYCLABLE
CARDBOARD



PRINTED IN
BIC FACTORIES



REGULATORY
COMPLIANCE

PRINTING TECHNIQUES

PD PAD PRINTING

BP BRITEPIX™
BRITEPIX™ PERSONALISATION

LE LASER

SUSTAINABILITY



BIC® CLIP CASE

2398

BIC® CLIP CASE
2398



All cases are delivered with a white BIC® J25 lighter!



03

02

1:1 scale

2398

BIC® CLIP CASE
2398

MOQ 100 units
A/C PD: max. 1 col.

MOQ 100 units
A/C BP: full-colour
BP Texture: full-colour

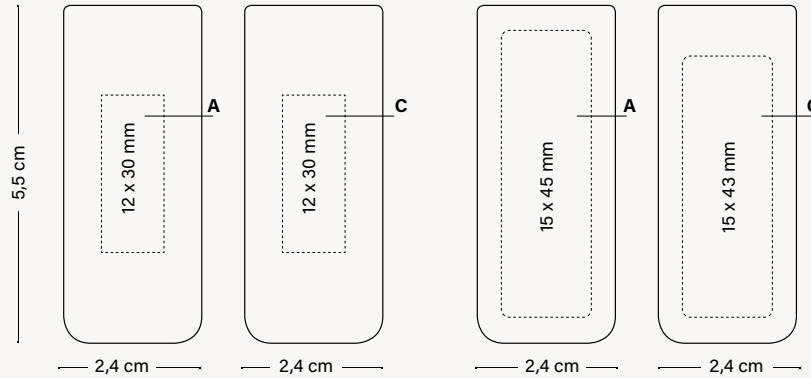

PACKAGING



STANDARD PACKAGING:
BOX FOR 50 UNITS

EXTERNAL PACKAGING



300 ± 7,5 KG



FSC AND
RECYCLABLE
CARDBOARD



PRINTED IN
BIC FACTORIES



REGULATORY
COMPLIANCE



PRINTING TECHNIQUES

PD PAD PRINTING

BP BRIPEPIX™
BRIPEPIX™ PERSONALISATION

SUSTAINABILITY



See pages 272-276 for a detailed explanation of the icons.

2395

BIC® 3D CASE
2395



All cases are delivered with a white BIC® J25 lighter!



Convert your logo into a 3D shape!

BIC® 3D CASE

2395

BIC® 3D CASE

2395

A/C 3D: max. 6 col.

MOQ 1.200 units

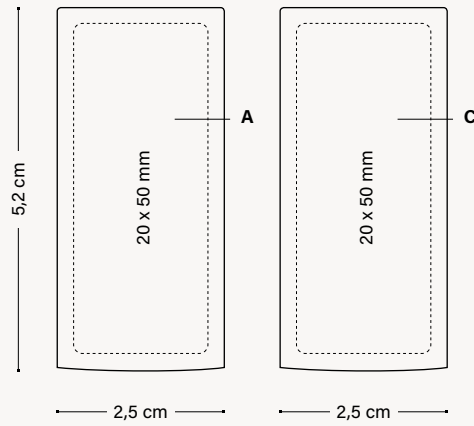

PACKAGING



STANDARD PACKAGING:
BOX FOR 50 UNITS

EXTERNAL PACKAGING



300 ± 7,5 KG



FSC AND
RECYCLABLE
CARDBOARD



REGULATORY
COMPLIANCE



PRINTING
TECHNIQUES



EMBOSSING

BIC
GRAPHIC

BIC®
WRITING INSTRUMENTS

OTHER WRITING
INSTRUMENTS

NOTEBOOKS

BIC® / DJEEP® LIGHTERS
AND BIC® CASES

BIC®
PACKAGING

GENERAL
INFORMATION

See pages 272-276 for a detailed explanation of the icons.

BIC® POCKET ASHTRAY

3850

BIC® POCKET ASHTRAY
3850

6 different
flap shapes
available!

Reusable and
hermetic!



1:1 scale

3850

BIC® POCKET ASHTRAY
3850

A SP: max. 5 col. (max. 2 col.
for orders under 20.000 pcs.)

MOQ 5.000 units

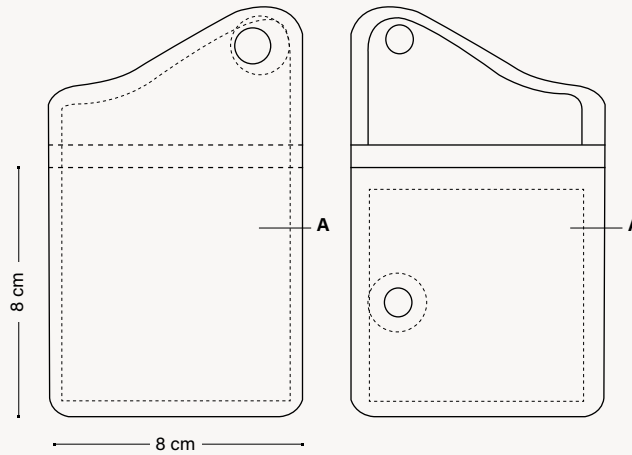

PACKAGING



BOX FOR 10 UNITS EACH
BIC® POCKET ASHTRAY
COMES IN AN INDIVIDUAL
CELLOPHANE PACKAGING

EXTERNAL PACKAGING



500 ± 5,5 KG



REGULATORY
COMPLIANCE

PRINTING TECHNIQUES

SP SCREEN PRINTING

Please contact your Customer Service Representative for further details.

BIC® POCKET ASHTRAY

3851

BIC® POCKET ASHTRAY
3851 Kraft



1:1 scale

6F

3851

BIC® POCKET ASHTRAY KRAFT

3851 Kraft

A SP: max. 2 col.

MOQ 10.000 units

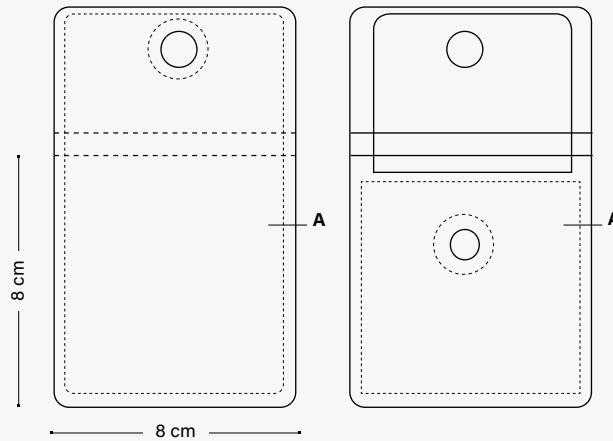

PACKAGING



BOX FOR 10 UNITS EACH
BIC® POCKET ASHTRAY
COMES IN AN INDIVIDUAL
CELLOPHANE PACKAGING.

EXTERNAL PACKAGING



500 ± 5,5 KG



REGULATORY
COMPLIANCE

PRINTING TECHNIQUES



SCREEN PRINTING

See pages 272-276 for a detailed explanation of the icons.

DJEEP® LIGHTERS

Long-lasting and designed with style. DJEEP® is crafted to function perfectly. Each lighter is fully tested to ensure it meets our top-quality criteria.

FR/

Durable et conçu avec style. Le briquet DJEEP® est créé pour fonctionner parfaitement. Chaque briquet est entièrement testé pour s'assurer qu'il répond à nos critères de qualité les plus stricts.

DE/

Langlebig und stilvoll gestaltet. DJEEP® ist so konzipiert, dass es perfekt funktioniert. Jedes Feuerzeug wird eingehend getestet, um sicherzustellen, dass es unsere hohen Qualitätskriterien erfüllt.

IT/

Di lunga durata e progettato con stile. Ogni accendino è completamente testato per garantire la soddisfazione dei nostri criteri di massima qualità.

ES/

Duradero y diseñado con estilo. DJEEP® está diseñado para funcionar a la perfección. Cada encendedor se somete a pruebas exhaustivas para garantizar que cumple nuestros criterios de máxima calidad.



08D1
DJEEP® D1 Lighter



08D1
DJEEP® D1 Lighter



08D1
DJEEP® D1 Lighter



08D1
DJEEP® D1 Lighter

Ignite your spark

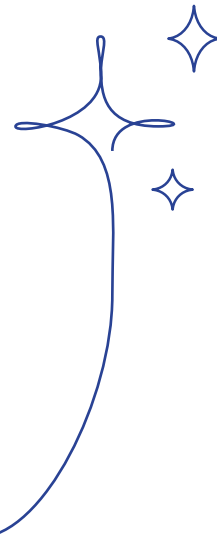



**Ignite your
mark.**

We are
premium

We are
singular



We are
engaged

We are
creative

DJEEP® D1 LIGHTER

Long-lasting and designed with style. DJEEP® is crafted to function perfectly. Each lighter is fully tested to ensure it meets our top-quality criteria.



STABLE FLAME

thanks to pure isobutane fuel



A LONG-LASTING LIGHTER

thanks to triple-tank technology



HIGH RESISTANCE

reservoir made of high mechanical resistance resin



LARGER PUSHER

for a better comfort of use



HIGH-END EFFECTS

QUALITY MADE
compliant with international safety standards. Made in France



UNIQUE RECTANGULAR SHAPE

to offer comfort in hand and a large surface of expression

CHILD-RESISTANT SAFETY GUARD

compliant with EN 13869 Standard



FR /
Flamme stable.
Grand poussoir.
Un briquet conçu pour durer.
Effets haut de gamme.
Très résistant.
Forme rectangulaire unique.
Sécurité enfants.

DE /
Stabile Flamme.
Großer Drücker.
Ein langlebiges Feuerzeug.
Hochwertige Effekte.
Hohe Widerstandsfähigkeit.
Einzigartige rechteckige Form.
Kindersicherung.

IT /
Fiamma stabile.
Pulsante grande.
Un accendino di lunga durata.
Effetti di alta gamma.
Alta resistenza.
Forma rettangolare unica.
Dispositivo di sicurezza
a prova di bambino.

ES /
Llama estable.
Pulsador grande.
Un encendedor de
larga duración.
Efectos de gama alta.
Alta resistencia.
Forma rectangular única.
Protección de seguridad
a prueba de niños.

360° Digital Decoration

DJEEP® offers a wide variety of digital printing effects; select from touch & feel, glossy & matt mix, etched, Holographik®, ... to elevate each lighter.



01. Base. Select between:
 WM WHITE MEDIUM M METALLIC SILVER H HOLOGRAPHIC

03. Finish. Select between:
 G GLOSSY MT MATT ST DJEEP SOFT TOUCH®

02. Printing: We select the best option for you (digital, offset, flexo, silk screen ...) depending on quantity and design options.

04. Decoration options. Select up to 2 different decoration options between: GRANITE, FABRIC, DJEEP® SOFT TOUCH®, RESIN CHIP, TOUCH&FEEL, GLOSSY & MATT MIX, BLACK LIGHT, HAMMERED METAL, GLITTERING, FRAGRANT INK, GLOW IN THE DARK, ETCHED, QR CODE, HOLOGRAPHIK®, PEARLESCENT.

DECORATION POSSIBILITIES



ST

DJEEP® SOFT TOUCH®

Provide a unique smooth sensation! Deep tones and a soft surface for an exclusive experience.



GT

GLITTERING

Add a sparkling effect to your design! Make your colours vibrant!



HM

HAMMERED METAL

A metallic background with a puffy effect pattern. A premium look and feel that stands out!

DJEEP® LIGHTERS



TF

TOUCH & FEEL

Give an embossed effect to your design!



ET

ETCHED

Gives an etched or engraved effect to the lighter!
Create patterns and convert your idea into an elegant design.



GM

GLOSSY & MATT MIX

Choose this finish to create distinctions between matt or DJEEP® Soft Touch® or the UV varnish that produces vivid colours.



FI

FRAGRANT INK

Rub the label and enjoy the fragrance!
Available fragrances: Mint, Red Fruits, Mojito, Lime and Pineapple.



OR

QR CODE

Redirect your customer to a website, phone number or message. Create interactivity between the lighter and your message!



BL

BLACK LIGHT

Under a black light the fluor colours appear.
You can have light blue, red, green or yellow.



FA

FABRIC

Give it the look and feel of fabric with a relief effect and matt finish!



RC

RESIN CHIP

Add volume to your design!
Give the lighter a third dimension!



GR

GRANITE

Add a granular feel to the lighter!



GD

GLOW IN THE DARK

Expose the DJEEP® lighter to a light bulb or direct sunlight and observe the photoluminescent powder in dark places!



H

HOLOGRAPHIK®

A reflective silvery surface to show high quality and innovation!



PE

PEARLESCENT

Pearly and subtle shine that transmits elegance and delicacy!

BIC GRAPHIC

BIC® WRITING INSTRUMENTS

OTHER WRITING INSTRUMENTS

NOTEBOOKS

BIC® / DJEEP® LIGHTERS AND BIC® CASES

BIC® PACKAGING

GENERAL INFORMATION

DJEEP® LIGHTERS

08D1

DJEEP® D1 LIGHTER
08D1

MOQ 10.000 units
Standard colours combination



No extra charge

Hood

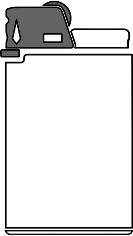

Pusher

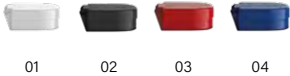
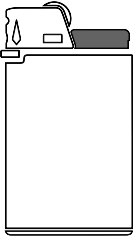

Reservoir

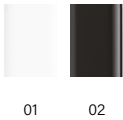

DJEEP® LIGHTERS

08D1

DJEEP® D1 LIGHTER

08D1

A DG: full-colour

MOQ 10000 units

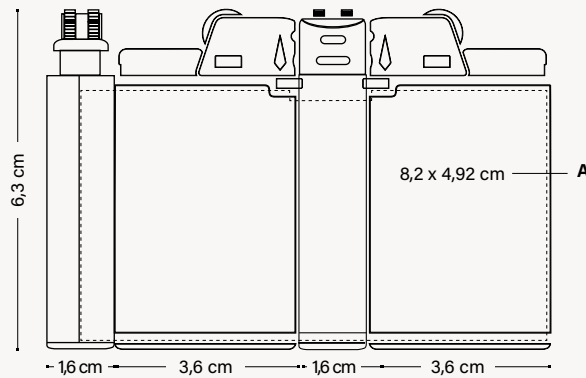

PACKAGING



STANDARD PACKAGING:
IN TRAY OF 10 UNITS

Recyclable cardboard

EXTERNAL PACKAGING



600 ± 20 KG



FSC AND
RECYCLABLE
CARDBOARD



MANUFACTURED AND
PRINTED IN DJEEP
FACTORIES



REGULATORY
COMPLIANCE



UP TO 3.500



PRINTING
TECHNIQUES



DIGITAL

SUSTAINABILITY



100% ELECTRICITY
COMING FROM
RENEWABLE SOURCES



Check out
the video

See pages 272-276 for a detailed explanation of the icons.