



forniture  
industriali

# Work

## Professional



AWKPANKA  
kaki

AWKPA2NE  
nero



AWKPANBL  
blu

## Pantalone Work

**cod. AWKPAN/AWKPA2**

Pantalone multitasche con elastico in vita, cerniera coperta, due tasche, due tasconi posteriori e due tasconi laterali tutti chiusi da pattina con velcro.

**Composizione tessuto:**

65% poliestere - 35% cotone

**Grammatura tessuto:** 240 gr/mq

**Taglie:**

dalla S alla XXXL

**Box:** da 20 pz. per taglia



AWKPANKA  
kaki



AWKPANBL  
blu



AWKPANGR  
grigio



AWKPA2VE  
verde militare



AWKPA2NE  
nero

AWKPANGR  
grigio

segue

## Professional



AWKPA2VE  
verde militare

## Pantalone Work

**cod. AWKPAN/AWKPA2**

Pantalone multitasche con elastico in vita, cerniera coperta, due tasche, due tasconi posteriori e due tasconi laterali tutti chiusi da pattina con velcro.

**Composizione tessuto:**

65% poliestere - 35% cotone

**Grammatura tessuto:** 240 gr/mq

**Taglie:**

dalla S alla XXXL

**Box:** da 20 pz. per taglia

-  AWKPANKA  
kaki
-  AWKPANBL  
blu
-  AWKPANGR  
grigio
-  AWKPA2VE  
verde militare
-  AWKPA2NE  
nero



## Pantalone Pockets

### cod. APKPAN

Pantalone multitasche con elastico in vita, cerniera coperta, due tasche, due tasconi posteriori e due tasconi laterali tutti chiusi da pattina con velcro.

### Composizione tessuto:

100% cotone sanforizzato

Grammatura tessuto: 240 gr/mq

### Taglie:

dalla S alla XXXL

Box: da 15 pz. per taglia

 APKPANGR  
grigio

 APKPANBL  
blu



APKPANGR  
grigio

APKPANBL  
blu



AMXPANNE  
nero

## Pantalone Maddox



### cod. AMXPAN

Pantalone Maddox in tessuto stretch 4-way con inserti in poliestere Oxford, elastici laterali in vita, bottone antigraffio e cerniera coperta, due tasche davanti e due tasche posteriori di cui una applicata e una a fletto, due tasconi con pattina alle gambe, con gancio portabadge (non incluso), su gamba sinistra tasca obliqua per cellulare con pattina per una facile personalizzazione, cuciture a contrasto, profilo rinfrangente alle ginocchia.

### Composizione tessuto:

92% nylon - 8% spandex

**Grammatura tessuto:** 220 gr/mq

### Taglie:

dalla S alla XXXL

**Box:** da 10 pz. per taglia

-  AMXPANNE  
nero
-  AMXPANBL  
blu
-  AMXPANGR  
grigio





AMXPANGR  
grigio



# Maddox



AMXPANBL  
blu





## Bermuda Maddox in arrivo



# Flexy stretch

Professional

◀ **STRETCH** ▶



AFLPANBL  
blu notte/nero

## Pantalone Flexy

### cod. AFLPAN

Pantalone bicolore multitasche con cuciture a contrasto, elastico in vita e soffietto alle ginocchia per un'ottima vestibilità, cerniera coperta, cavallo rinforzato, due tasche e taschino portamonete davanti, due tasconi posteriori di cui uno chiuso da pattina con velcro, tascone con pattina chiusa da velcro su gamba sinistra, tasca portametro con taschino supplementare chiuso da velcro e passante portamartello su gamba destra.

### Composizione tessuto:

98% cotone - 2% elasthan

Grammatura tessuto: 245 gr/mq

### Taglie:

dalla S alla XXXL

Box: da 10 pz. per taglia



AFLPANBL  
blu notte/nero



AFLPANGR  
grigio piombo/nero



◀ **STRETCH** ▶



AFLPANGR  
grigio piombo/nero

## Professional



ASGPANBL  
blu/nero

## Pantalone invernale Sigma

### cod. ASGPAN

Pantalone invernale foderato, bicolore multitasche con cuciture a contrasto, elastico in vita e soffietto alle ginocchia per un'ottima vestibilità, cerniera coperta, cavallo rinforzato, due tasche e taschino portamonete davanti, due tasconi posteriori di cui uno chiuso da pattina con velcro, tascone con pattina chiusa da velcro su gamba sinistra, tasca portametro con taschino supplementare chiuso da velcro e passante portamartello su gamba destra.

### Composizione tessuto:

100% cotone

### Grammatura tessuto:

250 gr/mq ESTERNO

160 gr/mq INTERNO

### Taglie:

dalla S alla XXXL

**Box:** da 10 pz. per taglia



ASGPANBL  
blu/nero



ASGPANGR  
grigio/nero

**fodera interna**

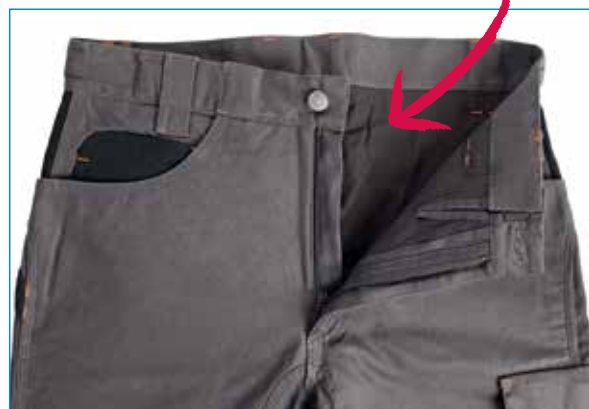

ASGPANGR  
grigio/nero





# Delta

## Professional



ADLPANGR  
grigio/nero

## Pantalone Delta

### cod. ADLPAN

Pantalone bicolore multitasche con cuciture a contrasto, elastico in vita e soffietto alle ginocchia per un'ottima vestibilità, cerniera coperta, cavallo rinforzato, due tasche e taschino portamonete davanti, due tasconi posteriori di cui uno chiuso da pattina con velcro, tascone con pattina chiusa da velcro su gamba sinistra, tasca portametro con taschino supplementare chiuso da velcro e passante portamartello su gamba destra.

### Composizione tessuto:

100% cotone

**Grammatura tessuto:** 240 gr/mq

### Taglie:

dalla S alla XXXL

**Box:** da 10 pz. per taglia

 ADLPANBL  
blu/nero

 ADLPANGR  
grigio/nero

ADLPANBL  
blu/nero







# Delta

## Professional



ADLGILBL  
blu/nero

ADLGILGR  
grigio/nero





## Gilet Delta

### cod. ADLGIL

Gilet bicolore multitasche, profilo rinfrangente davanti, doppio taschino e tasca sul petto con pattina e chiusura in velcro, due tasconi di cui uno chiuso da cerniera, una tasca con zip e fodera rinforzata per utensili, ampia tasca posteriore con cerniera.

### Composizione tessuto:

100% cotone

**Grammatura tessuto:** 240 gr/mq

### Taglie:

dalla S alla XXXL

**Box:** 10 pz. per taglia

 ADLGILBL  
blu/nero

 ADLGILGR  
grigio/nero

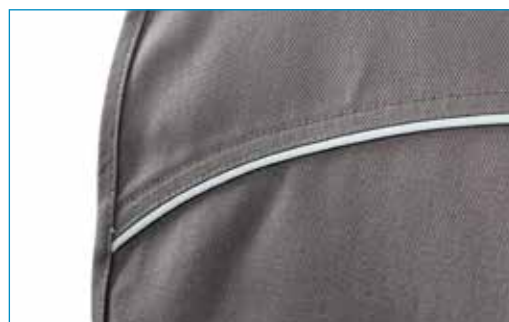



# Ripstop

## Professional



ARPPANGR  
grigio

ARPPANBL  
blu



## Pantalone Ripstop

### cod. ARPPAN

Pantalone multitasche in tessuto "Ripstop" antistrappo resistente alle lacerazioni, con elastico in vita nella parte posteriore, cerniera coperta, due tasche anteriori, due tasche posteriori con pattina e velcro, tascone con pattina e velcro gamba sinistra, tascone e portametro su gamba destra.

### Composizione tessuto:

100% cotone lavorazione "Ripstop"

### Grammatura tessuto:

200 gr/mq.

### Taglie:

dalla S alla XXXL

**Box:** 10 pz. per taglia

ARPPANBL  
blu

ARPPANGR  
grigio







# Ripstop

## Professional



ARPERBG  
blu/grigio



## Bermuda Ripstop

### cod. ARPERB

Bermuda multitasche, in tessuto "Ripstop" antistrappo resistente alle lacerazioni, con elastici laterali in vita, bottoni coperti, due tasche anteriori, due tasche posteriori con pattina e velcro, tascone con pattina e velcro gamba sinistra, tascone e portametro su gamba destra.

### Composizione tessuto:

100% cotone, lavorazione "Ripstop"

### Grammatura tessuto:

200 gr/mq.

### Taglie:

bicolore: dalla S alla XXL

blu o grigio: dalla S alla XXXL

**Box:** 20 pz. per taglia

-  ARPERBG  
blu/grigio
-  ARPERBL  
blu
-  ARPERGR  
grigio





ARPBEBL  
blu



ARPBEBGR  
grigio



# Stretch

## Professional



ASTPANBL  
blu

## Pantalone Stretch

### cod. ASTPAN

Pantalone Stretch con inserti tessuto "Indura", elastici laterali in vita, cerniera coperta, due tasche davanti e due tasche posteriori con pattina e velcro, tasca obliqua alla gamba sinistra con doppia tasca per cellulare con pattina per una facile personalizzazione, tascone con gancio portabadge su gamba destra, aperture per inserimento imbottiture alle ginocchia, profilo rinfrangente sotto la cintura posteriore e alle ginocchia.

### Composizione tessuto:

98% cotone - 2% elasthan  
inserti 100% poliestere

### Grammatura tessuto:

240 gr/mq

Taglie: dalla S alla XXXL

Box: 10 pz. per taglia



ASTPANBL  
blu



ASTPANGR  
grigio



ASTPANNE  
nero



**stretch**



◀ **STRETCH** ▶



ASTPANGR  
grigio



new color

ASTPANNE  
nero

segue ▶

### Pantalone Stretch

**cod. ASTPAN**

Pantalone Stretch con inserti tessuto "Indura", elastici laterali in vita, cerniera coperta, due tasche davanti e due tasche posteriori con pattina e velcro, tasca obliqua alla gamba sinistra con doppia tasca per cellulare con pattina per una facile personalizzazione, tascone con gancio portabadge su gamba destra, aperture per inserimento imbottiture alle ginocchia, profilo rinfrangente sotto la cintura posteriore e alle ginocchia.

**Composizione tessuto:**

98% cotone - 2% elasthan  
inserti 100% poliestere

**Grammatura tessuto:**

240 gr/mq

**Taglie:** dalla S alla XXXL

**Box:** 10 pz. per taglia



ASTPANBL  
blu



ASTPANGR  
grigio



ASTPANNE  
nero



\* protezioni non fornite





◀ **STRETCH** ▶



ideale per ricamo/stampa logo



# Gamma

## Professional



AGMPANGR  
grigio/arancio



## Pantalone Gamma

### cod. AGMPAN

Pantalone multitasche bicolore modello "GAMMA" con elastico in vita, bottoni coperti, due tasche davanti con soffietto in contrasto, tasca posteriore e tasca su gamba destra con soffietto in contrasto, chiuse da pattina con velcro.

### Composizione tessuto:

65% poliestere - 35% cotone

**Grammatura tessuto:** 235 gr/mq

**Taglie:** dalla S alla XXXL

**Box:** da 20 pz. per taglia

 AGMPANGR  
grigio/arancio

 AGMPANNE  
nero/grigio

 AGMPANBL  
blu/rosso

AGMPANNE  
nero/grigio

AGMPANBL  
blu/rosso

# Speedy stretch

## Professional



ASPTUTGR  
grigio piombo/nero

## Tuta Speedy

### cod. ASPTUT

Tuta lavoro modello "Speedy" con cerniera coperta, elastico in vita, velcro ai polsi, mezze maniche staccabili con cerniera, due tasche anteriori, due tasche posteriori con velcro, taschino con portapenne e portacellulare al petto, tascone con pattina su gamba sinistra, doppia tasca applicata su gamba destra, aperture per inserimento protezioni alle ginocchia.

**Composizione tessuto:**  
98% cotone - 2% elasthan

**Grammatura tessuto:** 245 gr/mq

**Taglie:**  
dalla S alla XXXL

**Box:** da 10 pz. per taglia



ASPTUTGR  
grigio piombo/nero



mezze  
maniche  
staccabili



## ◀ STRETCH ▶



\* protezioni  
non fornite

# Speedy stretch

Professional



ASPSALGR  
grigio piombo/nero

## Salopette Speedy

### cod. ASPSAL

Salopette lavoro modello "Speedy" con cerniera laterale, bretelle elasticizzate, ganci in plastica, due tasche anteriori, due tasche posteriori con velcro, tascone frontale con portapenne e portacellulare, tascone con pattina su gamba sinistra, doppia tasca applicata su gamba destra, aperture per inserimento protezioni alle ginocchia.

### Composizione tessuto:

98% cotone - 2% elasthan

### Grammatura tessuto:

245 gr/mq

### Taglie:

dalla S alla XXXL

**Box:** da 15 pz. per taglia



ASPSALGR  
grigio piombo/nero

◀ **STRETCH** ▶





# Speedy stretch

## Professional



ASPPANGR  
grigio piombo/nero

## Pantalone Speedy

### cod. ASPPAN

Pantalone lavoro "Speedy" con bottoni coperti, elastici laterali in vita, due tasche anteriori, due tasche posteriori con velcro, tascone con pattina su gamba sinistra, doppia tasca applicata su gamba destra, aperture per inserimento protezioni alle ginocchia.

### Composizione tessuto:

98% cotone - 2% elasthan

**Grammatura tessuto:** 245 gr/mq

**Taglie:** dalla S alla XXXL

**Box:** da 10 pz. per taglia



ASPPANGR  
grigio piombo/nero





◀ **STRETCH** ▶



\* protezioni  
non fornite

# Speedy stretch

## Professional



ASPGIUGR  
grigio piombo/nero

## Giubbino Speedy

### cod. ASPGIU

Giubbino lavoro modello "Speedy" con cerniera coperta, elastici laterali al girovita, velcro ai polsi, maniche staccabili con cerniera, due tasconi, taschino con portapenne e portacellulare.

### Composizione tessuto:

98% cotone - 2% elasthan

**Grammatura tessuto:** 245 gr/mq

**Taglie:** dalla S alla XXXL

**Box:** da 10 pz. per taglia



ASPGIUGR  
grigio piombo/nero



◀ **STRETCH** ▶



representazione  
con maniche staccate

## Professional



AGLTUTBL  
blu/grigio

## Tuta Globo

### cod. AGLTUT

Tuta lavoro modello "Globo" con cerniera coperta, elastico in vita, velcro ai polsi, mezze maniche staccabili con cerniera, due tasche anteriori, due tasche posteriori con velcro, taschino con portapenne e portacellulare al petto, tascone con pattina su gamba sinistra, doppia tasca applicata su gamba destra, aperture per inserimento protezioni alle ginocchia.

### Composizione tessuto:

100% cotone sanforizzato con inserti in poliestere cotone

**Grammatura tessuto:** 280/290 gr/mq

### Taglie:

dalla S alla XXXL

**Box:** da 10 pz. per taglia



AGLTUTBL  
blu/grigio

mezze maniche  
staccabili





\* protezioni  
non fornite



# Globo

## Professional



AGLSALBL  
blu/grigio

## Salopette Globo

### cod. AGLSAL

Salopette lavoro modello "Globo" con cerniera laterale, bretelle elasticizzate, ganci in plastica, due tasche anteriori, due tasche posteriori con velcro, tascone frontale con portapenne e portacellulare, tascone con pattina su gamba sinistra, doppia tasca applicata su gamba destra, aperture per inserimento protezioni alle ginocchia.

### Composizione tessuto:

100% cotone sanforizzato con inserti in poliestere cotone

### Grammatura tessuto:

280/290 gr/mq

### Taglie:

dalla S alla XXXL

**Box:** da 12 pz. per taglia



AGLSALBL  
blu/grigio







# Globo

## Professional



AGLPANBL  
blu/grigio

## Pantalone Globo

### cod. AGLPAN

Pantalone lavoro "Globo" con bottoni coperti, elastici laterali in vita, due tasche anteriori, due tasche posteriori con velcro, tascone con pattina su gamba sinistra, doppia tasca applicata su gamba destra, aperture per inserimento protezioni alle ginocchia.

### Composizione tessuto:

100% cotone sanforizzato con inserti in poliestere cotone

**Grammatura tessuto:** 280/290 gr/mq

### Taglie:

dalla S alla XXXL

**Box:** 20 pz. per taglia



AGLPANBL  
blu/grigio









# Globo

## Professional

### Giubbino Globo

**cod. AGLGIU**

Giubbino lavoro modello "Globo" con cerniera coperta, elastici laterali al girovita, velcro ai polsi, maniche staccabili con cerniera, due tasconi, taschino con portapenne e portacellulare.

**Composizione tessuto:**

100% cotone sanforizzato con inserti in poliestere cotone

**Grammatura tessuto:**

280/290 gr/mq

**Taglie:**

dalla S alla XXXL

**Box:** 15 pz. per taglia



AGLGIUBL  
blu/grigio



AGLGIUBL  
blu/grigio



maniche staccabili



## Professional



AGLPANGR  
grigio

## Pantalone Globo tono su tono

### cod. AGLPAN

Pantalone lavoro "Globo" con bottoni coperti, elastici laterali in vita, due tasche anteriori, due tasche posteriori con velcro, tascone con pattina su gamba sinistra, doppia tasca applicata su gamba destra, aperture per inserimento protezioni alle ginocchia.

### Composizione tessuto:

100% cotone sanforizzato

### Grammatura tessuto:

240 gr/mq

### Taglie:

dalla S alla XXXL

Box: 20 pz. per taglia



AGLPANGR  
grigio chiaro/scuro





\* protezioni non fornite





## Professional



AGLGIUGR  
grigio

## Giubbino Globo tono su tono

### cod. AGLGIU

Giubbino lavoro modello "Globo" con cerniera coperta, elastici laterali al girovita, velcro ai polsi, maniche staccabili con cerniera, due tasconi, taschino con portapenne e portacellulare.

### Composizione tessuto:

100% cotone sanforizzato

### Grammatura tessuto:

240 gr/mq

### Taglie:

dalla S alla XXXL

**Box:** 15 pz. per taglia



AGLGIUGR  
grigio chiaro/scuro





representazione  
con maniche staccate

ATUTORBL  
blu

## Tuta Oro

### cod. ATUTOR/ATUTO2

Tuta lavoro modello "Oro" con cerniera coperta in plastica e tirazip in metallo, quattro tasche, elastico in vita e ai polsi e portametro.

#### Composizione tessuto:

100% cotone sanforizzato

**Grammatura tessuto:** 260 gr/mq

#### Taglie:

per colore blu: dalla 44 alla 64

per colore bianco, arancio, grigio, verde,  
royal: dalla S alla XXXL

**Box:** da 10 pz. per taglia

	ATUTO2WH bianco
	ATUTO2RY royal
	ATUTORBL blu
	ATUTO2GR grigio
	ATUTO2VE verde
	ATUTO2AR arancio







ATUT02WH  
bianco



ATUT02GR  
grigio



segue



# Oro



ATUTO2AR  
arancio



ATUTO2RY  
royal



## Tuta Oro

### cod. ATUTOR/ATUTO2

Tuta lavoro modello "Oro" con cerniera coperta in plastica e tirazip in metallo, quattro tasche, elastico in vita e ai polsi e portametro.

#### Composizione tessuto:





100% cotone sanforizzato

**Grammatura tessuto:** 260 gr/mq

#### Taglie:

per colore blu: dalla 44 alla 64  
per colore bianco, arancio, grigio, verde,  
royal: dalla S alla XXXL

**Box:** da 10 pz. per taglia

	ATUTO2WH bianco		ATUTO2GR grigio
	ATUTO2RY royal		ATUTO2VE verde
	ATUTORBL blu		ATUTO2AR arancio



ATUTO2VE  
verde

ASALORBL  
blu

## Salopette Oro

### cod. ASALOR/ASAL02

Salopette modello "Oro", con elastico sul retro e sulle bretelle, quattro tasche, portametro e ganci in plastica.

#### Composizione tessuto:

100% cotone sanforizzato

#### Grammatura tessuto:

260 gr/mq

#### Taglie:

per colore blu: dalla 44 alla 64

per colore verde, grigio: dalla S alla XXXL

**Box:** da 15 pz. per taglia

	ASALORBL blu
	ASAL02GR grigio
	ASAL02VE verde



ASAL02VE  
verde



ASAL02GR  
grigio



segue



ASALPAWH  
bianco

## Salopette Patrich

### cod. ASALPA

Salopette modello "Patrich", con elastico sul retro e sulle bretelle, quattro tasche, portametro e ganci in plastica.

### Composizione tessuto:

100% cotone sanforizzato

### Grammatura tessuto:

200 gr/mq

### Taglie:

dalla S alla XXXL

**Box:** da 15 pz. per taglia



ASALPAWH  
bianco



light fabric



## Pantalone Oro

**cod. APANOR/APAN02**

Pantalone lavoro modello "Oro" con elastico in vita, bottoni coperti, tre tasche e portametro.

**Composizione tessuto:**  
100% cotone sanforizzato

**Grammatura tessuto:**  
260 gr/mq

**Taglie:**  
per colore blu: dalla 44 alla 64  
per colore verde, grigio: dalla S alla XXXL

**Box:** da 20 pz. per taglia

-  APANORBL  
blu
-  APAN02GR  
grigio
-  APAN02VE  
verde



APANORBL  
blu

segue

APANO2VE  
verdeAPANO2GR  
grigio

## Pantalone Oro

### cod. APANOR/APANO2

Pantalone lavoro modello "Oro" con elastico in vita, bottoni coperti, tre tasche e portametro.

**Composizione tessuto:**  
100% cotone sanforizzato

**Grammatura tessuto:**  
260 gr/mq

**Taglie:**  
per colore blu: dalla 44 alla 64  
per colore verde, grigio: dalla S alla XXXL

**Box:** da 20 pz. per taglia

 APANORBL  
blu

 APANO2GR  
grigio

 APANO2VE  
verde





## Pantalone Kiparis

### cod. BPANKI

Pantalone lavoro modello "Kiparis" con elastico in vita, bottoni coperti, tre tasche, portametro su gamba destra e tascone con pattina velcro su gamba sinistra.

### Composizione tessuto:

100% cotone sanforizzato

### Grammatura tessuto:

220 gr/mq

**Taglie:** da 42 a 62

**Box:** da 25 pz. per taglia

BPANKIBI  
bianco



tascone su gamba sinistra



BPANKIBI  
bianco



## Giacca Oro

**cod. AGIAOR**

Giacca lavoro modello "ORO" con bottoni coperti e tre tasche.

**Composizione tessuto:**  
100% cotone sanforizzato

**Grammatura tessuto:**  
260 gr/mq

**Taglie:**  
dalla 44 alla 64

**Box:** da 15 pz. per taglia

 AGIAORBL  
blu



AGIAORBL  
blu



## Giubbino Oro cod.

### AGIUOR/AGIU02

Giubbino lavoro modello "Oro" con bottoni coperti e due tasche.

**Composizione tessuto:**

100% cotone sanforizzato

**Grammatura tessuto:**

260 gr/mq

**Taglie:**

per colore blu: dalla 44 alla 64  
per colore verde e grigio:  
dalla S alla XXXL

**Box:** da 15 pz. per taglia

-  AGIUORBL  
blu
-  AGIU02GR  
grigio
-  AGIU02VE  
verde

AGIU02GR  
grigio



AGIU02VE  
verde



AGIUORBL  
blu





ACAMKIBL  
blu

## Camice Kiparis

### cod. ACAMKI

Camice lavoro "Kiparis" con tre tasche, copribottone ed elastico ai polsi.

### Composizione tessuto:

100% cotone sanforizzato

**Grammatura tessuto:** 240 gr/mq

### Taglie:

dalla S alla XXXL

**Box:** da 15 pz. per taglia

-  ACAMKIBL  
blu
-  ACAMKIAZ  
royal
-  ACAMKIVE  
verde
-  ACAMKIBI  
bianco
-  ACAMKIGR  
grigio





ACAMKIVE  
verde



ACAMKIAZ  
royal



ACAMKIBI  
bianco



ACAMKIGR  
grigio





ACAUPAWH  
bianco

## Camice Lux con bottoni a pressione

### cod. ACAUPA

Camice lavoro "Lux" con bottoni a pressione coperti, tre tasche anteriori, elastico ai polsi.

**Composizione tessuto:**  
100% cotone sanforizzato

**Grammatura tessuto:**  
220 gr/mq

**Taglie:**  
dalla XS alla XXL

**Box:** da 15 pz. per taglia



ACAUPAWH  
bianco

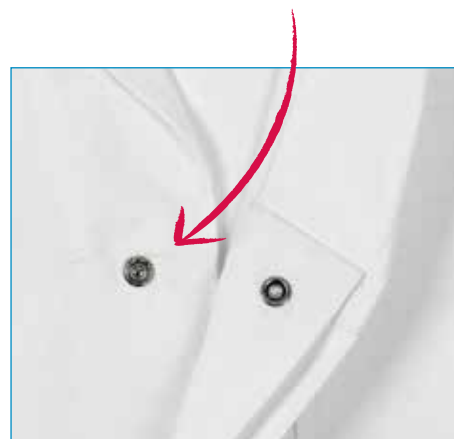





## Camice donna con bottoni a pressione

**cod. ACADPC**

Camice da donna con bottoni a pressione coperti, tre tasche anteriori, elastico ai polsi.

**Composizione tessuto:**

65% poliestere - 35% cotone

**Grammatura tessuto:** 130 gr/mq

**Taglie:** dalla S alla XL

**Box:** 30 pz. per taglia

ACADPCWH  
bianco



ACADPCWH  
bianco



## Camice con bottoni a pressione

### cod. ACAUPC

Camice da lavoro con bottoni a pressione coperti, tre tasche anteriori, elastico ai polsi.

### Composizione tessuto:

65% poliestere - 35% cotone

**Grammatura tessuto:** 130 gr/mq

### Taglie:

dalla S alla XXL

**Box:** 30 pz. per taglia

	ACAUPCWH bianco
	ACAUPCGR grigio
	ACAUPCBL blu
	ACAUPCNE nero

ACAUPCBL  
blu



ACAUPCNE  
nero



ACAUPCWH  
bianco



ACAUPCGR  
grigio





ACAMPCVE  
verde

## Camice Terital

**cod. ACAMPC**

Camice lavoro con tre tasche, copribottone ed elastico ai polsi.

**Composizione tessuto:**

65% poliestere - 35% cotone





**Grammatura tessuto:**

130 gr/mq

**Taglie:**

per colore royal e verde: dalla S alla XXXL  
per colore bianco e blu: dalla XS alla XXXL

**Box:** da 20 pz. per taglia

-  ACAMPCBL  
blu
-  ACAMPCRY  
royal
-  ACAMPCVE  
verde
-  ACAMPCBI  
bianco

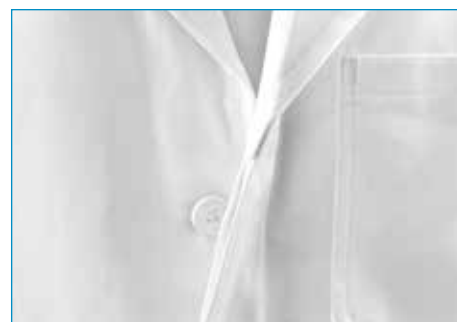

ACAMPCBL  
blu



ACAMPCBI  
bianco



ACAMPCRY  
royal

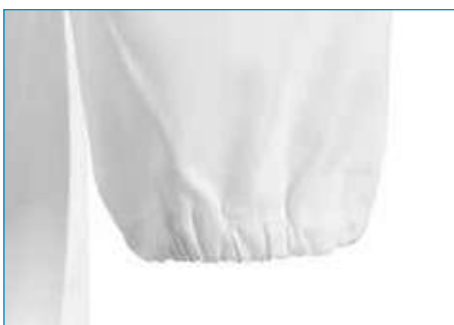



CCAUXML  
manica lunga

CCAUXMM  
mezza manica



## Camicia Chambree

**cod. CCAUX ML**  
manica lunga

**cod. CCAUX MM**  
mezza manica

Camicia Chambree "Job Style" con  
due taschini e portapenne.

**Composizione tessuto:**  
100% cotone

**Taglie:**  
dalla S alla XXXL

**Box:** da 10 pz. per taglia





## Jeans 14 once

**cod. AJTRAD14**

Jeans 14 once, stone-washed.

**Composizione tessuto:**

100% cotone

**Taglie:**

dalla 42 alla 60

**Box:** da 10 pz. per taglia



AJTRAD14







forniture  
alberghiere  
e medico-sanitarie



## Giacca Cuoco Lux

### cod. BGILUX

Giacca da cuoco manica lunga, doppio petto, chiusura con bottoni estraibili, taschino lato cuore e doppio taschino su manica sinistra.

**Composizione tessuto:**  
100% cotone

**Taglie:**  
dalla S alla XXL

**Box:** 15 pz. per taglia

**Colore nero:** ad esaurimento



BGILUXNE  
nero





BGILUXBI  
bianco

APANCOBI  
biancoACASCOBI  
bianco

## Casacca cotone collo V

### cod. ACASCO

Casacca cotone collo a V, manica americana e tre tasche.

**Composizione tessuto:** 100% cotone sanforizzato

**Grammatura tessuto:** 220 gr/mq

**Taglie:** dalla XS alla XXXL

**Box:** da 20 pz. per taglia

ACASCOBI  
bianco

## Pantalone elastico vita

### cod. APANCO

Pantalone bianco con elastico in vita, coulisse e due tasche.

**Composizione tessuto:** 100% cotone sanforizzato

**Grammatura tessuto:** 220 gr/mq

**Taglie:** dalla XS alla XXXL

**Box:** da 20 pz. per taglia

APANCOBI  
bianco



## Bustina con retina

**cod. BCAP01BI** (bianco)  
Bustina con retina.

**Composizione tessuto:**  
100% cotone, retina in poliestere

**Taglie:** unica

**Box:** da 100 pz.



## Cappello Cuoco

**cod. Y18177**  
Cappello da cuoco,  
chiusura con velcro.

**Composizione tessuto:**  
100% cotone

**Taglie:** unica

**Box:** da 100 pz.



## Cuffia con retina

**cod. BCAP02BI** (bianco)  
Cuffia con retina, elastico posteriore.

**Composizione tessuto:**  
100% cotone, retina in poliestere

**Taglie:** unica

**Box:** da 100 pz.



## Strofnaccio Torcione

**cod. BSTROF**

vedi pag. 112



## Pantalone Cuoco con coulisse

**cod. BPANCL**

Pantalone da cuoco con coulisse interna, elastico in vita, due tasche davanti e una tasca dietro.

**Composizione tessuto:**

100% cotone

**Taglie:** dalla XS alla XXXL

**Box:** 15 pz. per taglia



BPANCLBN  
bianco/nero



**Pantalone  
elastico vita**

cod. APANCOBI

vedi pag. 80

## Pantalone Cuoco

**cod. BPANPE**

Pantalone "Pepito" tinto filo, con cerniera coperta, due tasche davanti una tasca dietro.

**Composizione tessuto:**

100% cotone sanforizzato

**Taglie:** dalla 42 alla 62

**Box:** 20 pz. per taglia



BPANPEBN  
bianco/nero



## Pantalone Kiparis

cod. BPANKIBI

vedi pag. 61



**Structure**  
NUW20112  
nero



## **Structure** cod. NUW20112 **Response Grip** cod. NUW20032

**Tomaia:** Safety Dry, idrorepellente, traspirante

**Puntale:** AirToe Composite forato con membrana traspirante

**Antiperforazione:** non presente

**Taglie:** dalla 35 alla 48

**Box:** da 10 paia per taglia



**Response Grip**  
NUW20032  
bianco



## **Nurse Grip** cod. NUW20031

**Tomaia:** Microfibra Lucky

**Puntale:** AirToe Composite forato con membrana traspirante

**Antiperforazione:** non presente

**Taglie:** dalla 35 alla 48

**Box:** da 10 paia per taglia



**Nurse Grip**  
NUW20031  
bianco





## Super cod. NUW60061

## Surge Grip cod. NUW60041

**Tomaia:** Microfibra Lucky

**Puntale:** AirToe Composite forato con membrana traspirante

**Antiperforazione:** non presente

**Taglie:** dalla 35 alla 48

**Box:** da 10 paia per taglia



**Super**  
NUW60061  
nero



cinturino regolabile



**Surge Grip**  
NUW60041  
bianco



## Breeze Grip cod. NUW60011

## Sinergy Grip cod. NUW60021

**Tomaia:** Microfibra Lucky

**Puntale:** AirToe Composite forato con membrana traspirante

**Antiperforazione:** non presente

**Taglie:** dalla 35 alla 42

**Box:** da 10 paia per taglia



**Breeze Grip**  
NUW60011  
bianco



cinturino regolabile



**Sinergy Grip**  
NUW60021  
bianco





BW401295  
bianco/azzurro

## Casacca Paola stretch

### Cod. BW4012

Casacca donna stretch con inserti colorati, una tasca superiore e due doppie inferiori, di cui una chiusa con bottone a pressione.

### Composizione tessuto:

63% poliestere - 35% cotone - 2% elasthan

**Grammatura tessuto:** 165 gr/mq

**Taglie:** dalla 40 alla 60

**Box:** da 30 pz. per taglia

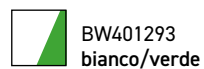
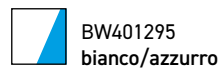

◀ **STRETCH** ▶



BW401293  
bianco/verde



BW401294  
bianco/fuxia



## Casacca Andrea stretch

### Cod. BW4010

Casacca donna stretch tinta unita, collo a V, due tasche frontali di cui una con porta penna.





### Composizione tessuto:

63% poliestere - 35% cotone - 2% elasthan

Grammatura tessuto: 165 gr/mq

Taglie: dalla 40 alla 60

Box: da 30 pz. per taglia

	BW401001 blu navy		BW401042 verde
	BW401000 bianco		BW401040 fuxia
	BW401041 azzurro		



BW401001  
blu navy

◀ **STRETCH** ▶



BW401041  
azzurro

BW401042  
verde

BW401040  
fuxia

BW401000  
bianco





## Pantalone Dante unisex stretch

### Cod. BW4402

Pantalone unisex stretch tinta unita con elastico e coulisse, multitasche, porta badge con elastico

### Composizione tessuto:

63% poliestere - 35% cotone - 2% elasthan

Grammatura tessuto: 165 gr/mq

Taglie: dalla XS alla 3XL

Box: da 30 pz. per taglia

 BW440200  
bianco

 BW440240  
fuxia

 BW440241  
azzurro

 BW440201  
blu navy

 BW440242  
verde

◀ **STRETCH** ▶



BW440200  
bianco



BW440242  
verde



BW440240  
fuxia



BW440201  
blu navy



◀ **STRETCH** ▶

## Bandana Adelina unisex stretch

### Cod. BW4701

Bandana stretch tinta unita con inserto parasudore e chiusura con lacci

### Composizione tessuto:

63% poliestere - 35% cotone - 2% elasthan

Grammatura tessuto: 165 gr/mq

Taglie: unica

Box: da 30 pz.



BW470101  
blu navy

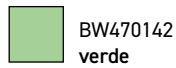

BW470142  
verde



BW470141  
azzurro



BW470140  
fuxia

BW470101  
blu navy



BW470141  
azzurro

BW470140  
fuxia

BW470142  
verde



BW400901  
blu navy

## Casacca Marco stretch

### Cod. BW4009

Casacca uomo stretch una tasca superiore e due doppie inferiori, di cui una chiusa con bottone a pressione.

### Composizione tessuto:

63% poliestere - 35% cotone - 2% elasthan

Grammatura tessuto: 165 gr/mq

Taglie: dalla S alla 3XL

Box: da 30 pz. per taglia

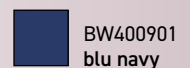

BW400901  
blu navy

◀ **STRETCH** ▶



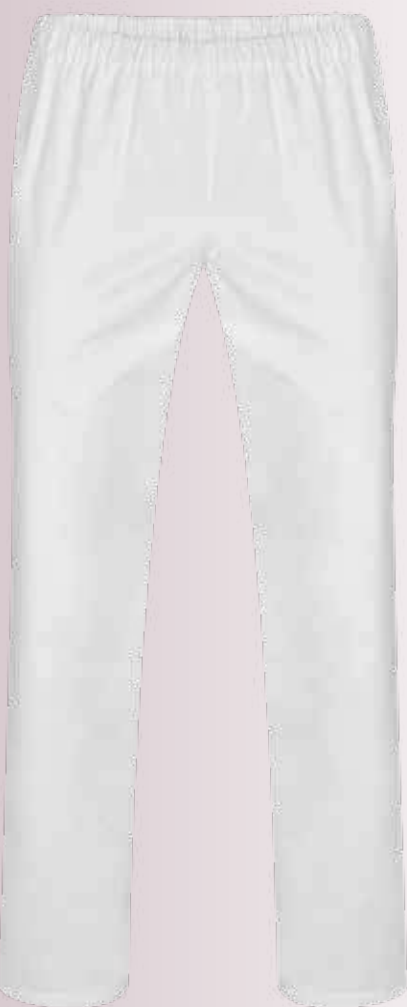

BW430200  
bianco

## Completo Colombo unisex

### Cod. BW4302

Completo unisex taglio confortevole. Casacca con mezza manica, collo a V tre tasche. Pantalone con elastico in vita, con e senza coulisse, tasca posteriore.

### Composizione tessuto:

65% poliestere - 35% cotone

**Grammatura tessuto:** 180 gr/mq

**Taglie:** dalla XS alla 3XL

**Box:** da 30 pz. per taglia



BW430201  
blu navy

BW430208  
bordeaux

BW430204  
piombo

BW430257  
verde



## Pantalone Batista unisex

### Cod. BW4401

Pantalone unisex tinta unita con elastico e tasca posteriore

### Composizione tessuto:

65% poliestere - 35% cotone

Grammatura tessuto: 160 gr/mq

Taglie: dalla XS alla 3XL

Box: da 30 pz. per taglia

ad esaurimento scorte

 BW440100 bianco	 BW440107 nero	 BW440113 azzurro
 BW440108 bordeaux	 BW440101 blu navy	 BW440114 verde



BW440101  
blu navy

BW440108  
bordeaux



BW440114  
verde



BW440107  
nero



BW440113  
azzurro



BW440100  
bianco





BW400223  
verdino

## Casacca Ines slim fit

### Cod. BW4002

Casacca donna Slim Fit, collo a V, manica corta, con due tasche frontali, spacchi laterali, sfiancata sulla schiena.

### Composizione tessuto:

65% poliestere - 35% cotone

**Grammatura tessuto:** 160 gr/mq

**Taglie:** dalla XS alla 3XL

**Box:** da 30 pz. per taglia

 BW400200  
bianco

 BW400213  
azzurro

 BW400223  
verdino

 BW400207  
nero



BW400213  
azzurro



BW400207  
nero



BW400200  
bianco



## Casacca Gabi

### Cod. BW4001

Casacca donna con bottoni trasparenti, una tasca superiore e due doppie inferiori, leggermente sfiancata e lunghezza fino ai fianchi.

### Composizione tessuto:

65% poliestere - 35% cotone

**Grammatura tessuto:** 160 gr/mq

**Taglie:** dalla XS alla 3XL

**Box:** da 30 pz. per taglia



BW400100  
bianco



BW400189  
azzurro



BW400196  
blu navy



BW400189  
azzurro



BW400100  
bianco



BW400196  
blu navy



BW440623  
verdino

## Pantalone Alessi unisex

### Cod. BW4406

PPantalone unisex tinta unita con elastico in vita, coulisse, due tasche davanti e una tasca posteriore

### Composizione tessuto:

65% poliestere - 35% cotone

**Grammatura tessuto:** 160 gr/mq

**Taglie:** dalla XS alla 3XL

**Box:** da 30 pz. per taglia

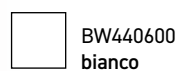

BW440600  
bianco

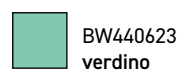

BW440623  
verdino



BW440601  
blu navy



BW440613  
azzurro



BW440600  
bianco



BW440601  
blu navy



BW440613  
azzurro







## Pantalone Cameriere

**cod. BPANPO**

Pantalone da cameriere, cerniera coperta, due tasche davanti e due tasche posteriori a filetto con bottone.

**Composizione tessuto:**

100% poliestere

**Taglie:**

dalla 40 alla 60

**Box:** 10 pz. per taglia



BPANPONE  
nero

BPANPONE  
nero



## Papillon

### cod. BPAPVI

Papillon da cameriere con gancio in metallo.

**Composizione tessuto:**  
100% poliestere

**Taglie:** unica

**Box:** da 50 pz.



BPAPVIBO  
bordeaux



BPAPVINE  
nero



BPAPVIBI  
bianco



BPAPVIBO  
bordeaux



BPAPVINE  
nero



BPAPVIBI  
bianco

## Camicia Cameriere

**cod. CCAFAN ML**  
manica lunga

**cod. CCAFAN MM**  
mezza manica

Camicia per cameriere bianca in  
poliestere-cotone.

**Composizione tessuto:**  
65% poliestere - 35% cotone

**Taglie:**  
dalla XS alla XXXL

**Box:** da 6 pz. per taglia

CCAFANML/MM  
bianco



CCAFANML  
manica lunga



CCAFANMM  
mezza manica

## Camicia Cameriera

**cod. CCADON ML**  
manica lunga

**cod. CCADON MM**  
mezza manica

Camicia per cameriera bianca in  
poliestere - cotone.

**Composizione tessuto:**  
65% poliestere - 35% cotone

**Taglie:**  
dalla XS alla XXL

**Box:** da 6 pz. per taglia

CCADONML/MM  
bianco



CCADONMM  
mezza manica



CCADONML  
manica lunga



## Falde Sommelier

**cod. BFPOPT**

Falde con pettorina, con bottoni per regolazione al collo, taschino doppio e due tasche.

**Composizione tessuto:**

100% poliestere

**Box:** da 25 pz.

 BFPOPTBO  
bordeaux

 BFPOPTNE  
nero







**BFPOPTNE**  
nero



**BFPOPTBO**  
bordeaux



## Falde corte in poliestere-cotone

**cod. BFPCCO**

Falde senza pettorina con tasca frontale doppia.

**Composizione tessuto:**

65% poliestere - 35% cotone

**Grammatura tessuto:** 240 gr/mq

**Misure indicative:** cm 68x40h

**Box:** da 50 pz.



BFPCCONE  
nero

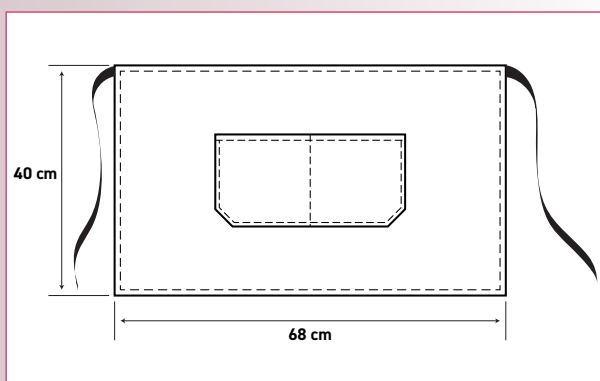

BFPCCONE  
nero

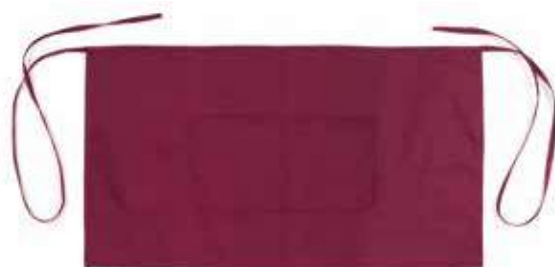
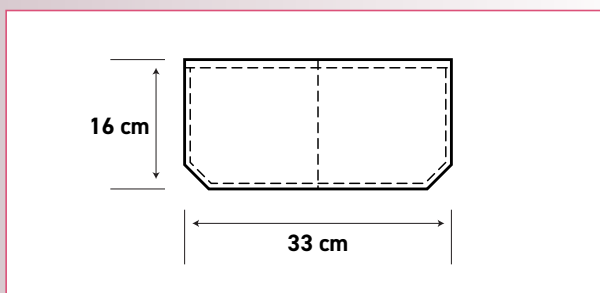

BFPCCOBO  
bordeaux

## Falde banconiere in poliestere-cotone

### cod. BFPCBA

Falde senza pettorina lunghe con aperture per accesso alle tasche.

### Composizione tessuto:

65% poliestere - 35% cotone

Grammatura tessuto: 240 gr/mq

Misure indicative: cm 96x89h

Box: da 50 pz.



BFPCBANE  
nero



BFPCBABO  
bordeaux



BFPCBARO  
rosso  
(ad esaurimento)



BFPCBABO  
bordeaux



BFPCBANE  
nero



BFPCBABO  
bordeaux



BFALBOTA  
bordeaux

## Falde Laccio Regolabile

### cod. BFAL BOTA / NETA

Falde con pettorina, con tascone e laccio regolabile in altezza.

#### Composizione tessuto:

100% cotone sanforizzato

**Grammatura tessuto:** 240 gr/mq

**Misure indicative:** cm 70x90h  
con tascone cm 30x30

**Box:** da 50 pz.



BFALBOTA  
bordeaux



BFALNETA  
nero



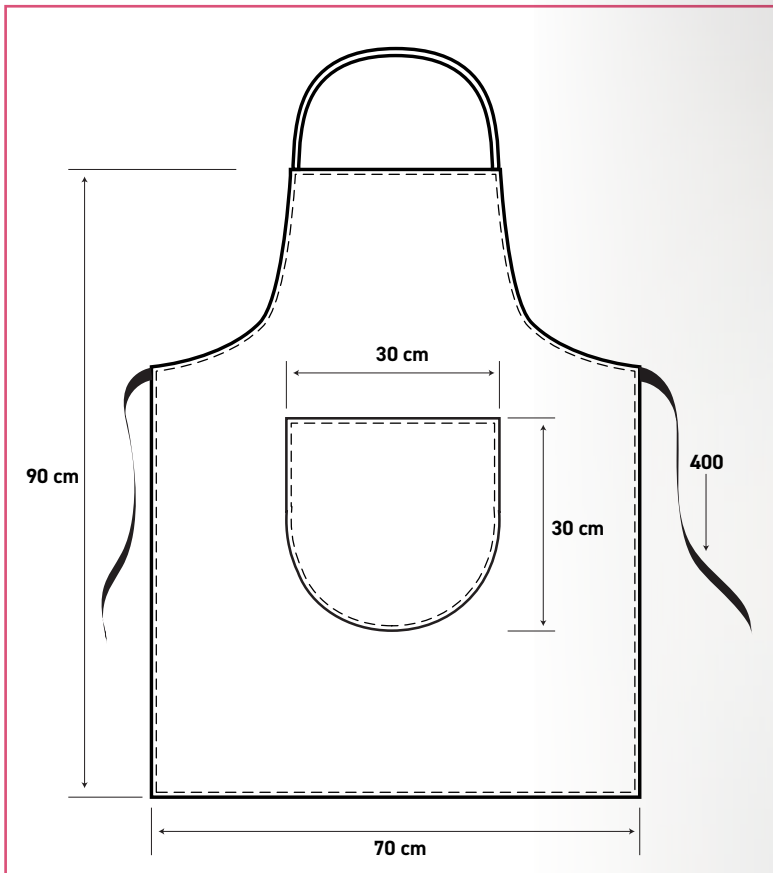

BFALNETA  
nero





BFALKIAZ  
royal

## Falde Kiparis con pettorina

### cod. BFALKI

Falde "Kiparis" con pettorina,  
senza tasca.

### Composizione tessuto:

100% cotone sanforizzato

Grammatura tessuto: 240 gr/mq

Misure indicative: cm 70x90h

Box: da 50 pz.



BFALKIBL  
blu



BFALKIVE  
verde



BFALKIAZ  
royal



BFALKIBL  
blu

## Falde Kiparis con pettorina e tasca

**cod. BFALTABL**

Falde "Kiparis" con pettorina e tasca.

**Composizione tessuto:**

100% cotone sanforizzato

**Grammatura tessuto:** 240 gr/mq

**Misure indicative:** cm 70x90h  
con tasca cm 17x20

**Box:** da 50 pz.



BFALKIVE  
verde



BFALKIAZ  
royal



BFALKI79  
bianco

## Falde Kiparis con pettorina

**cod. BFALKI79**

Falde "Kiparis" con pettorina  
senza tasca.

**Composizione tessuto:**  
100% cotone sanforizzato

**Grammatura tessuto:** 240 gr/mq

**Misure indicative:** cm 70x90h

**Box:** da 50 pz.



BFALKI79  
bianco





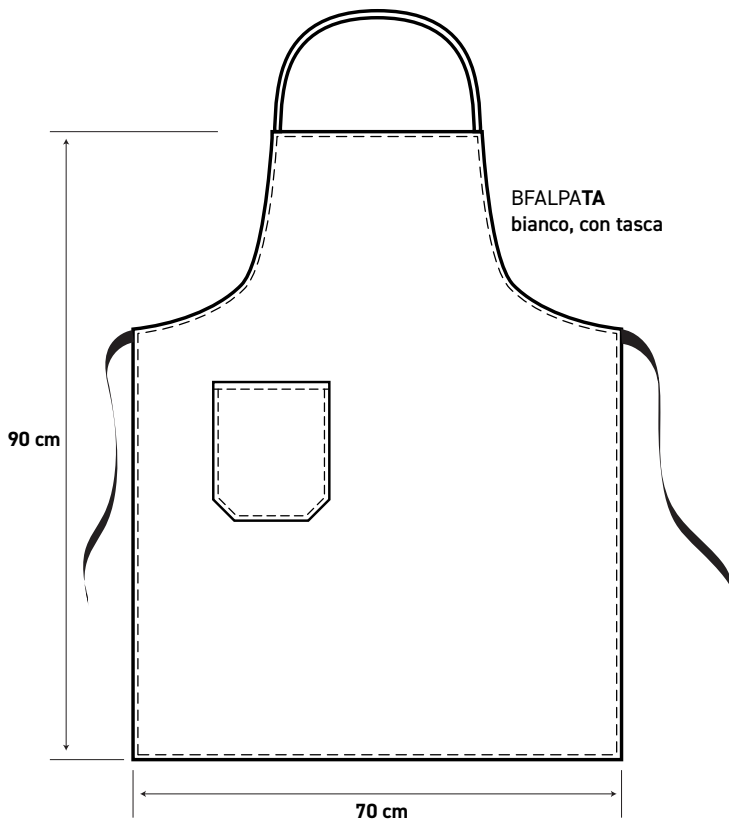

## Falde Patrich con pettorina

### cod. BFALPA

Falde "Patrich" con pettorina, senza tasca o con tasca 17x20.

### Composizione tessuto:

100% cotone sanforizzato

**Grammatura tessuto:** 200 gr/mq

### Misure indicative:

BFALPA79: cm 70x90h

BFALPATA: cm 70x90h con tasca cm 17x20

**Box:** da 50 pz.



BFALPA TA / 79  
bianco

BFALPA79  
bianco, senza tasca





BFALKI84  
bianco

## Falde Kiparis senza pettorina

**cod. BFALKI84**

Falde "Kiparis" senza pettorina.

**Composizione tessuto:**

100% cotone sanforizzato

**Grammatura tessuto:** 240 gr/mq

**Misure indicative:** cm 80x40h

**Box:** da 50 pz.

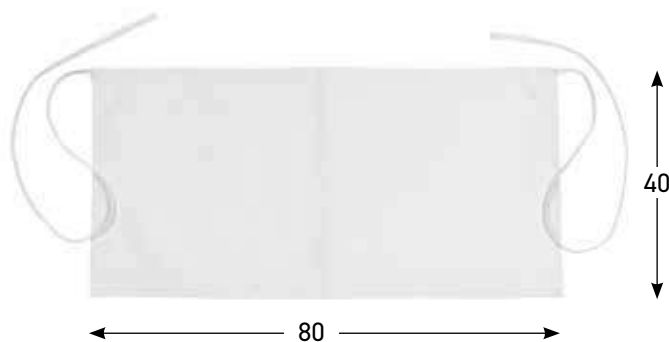

## Falde Kiparis senza pettorina

**cod. BFALKI67**

Falde "Kiparis" senza pettorina.

**Composizione tessuto:**

100% cotone sanforizzato

**Grammatura tessuto:** 240 gr/mq

**Misure indicative:** cm 70x60h

**Box:** da 50 pz.

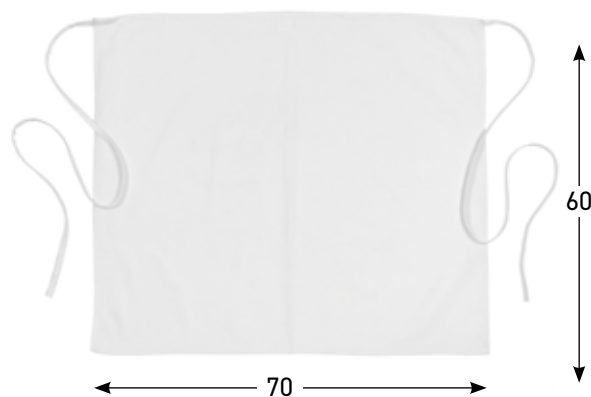

## Falde Patrich senza pettorina

**cod. BFALPA67**

Falde "Patrich" senza pettorina.

**Composizione tessuto:**

100% cotone sanforizzato

**Grammatura tessuto:** 200 gr/mq

**Misure indicative:** cm 70x60h

**Box:** da 50 pz.



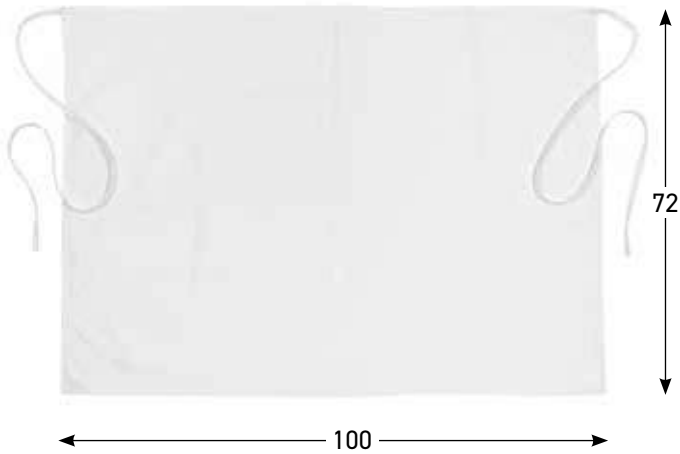

## Falde Kiparis senza pettorina

**cod. BFALKI71**

Falde "Kiparis" senza pettorina.

**Composizione tessuto:**

100% cotone sanforizzato

**Grammatura tessuto:** 240 gr/mq

**Misure indicative:** cm 100x72h

**Box:** da 50 pz.



BFALKI71  
bianco

BFALKI71  
bianco



**BSTROF68**  
bianco con bande colorate

**BSTROFWH**  
bianco

## Strofinaccio Torcione

### cod. BSTROF

Strofinaccio spinato bianco.  
I colori delle bande sono assortiti.

**Composizione tessuto:**  
100% cotone

**Misure indicative:**  
68: cm 60x80 con banda colorata  
WH: cm 60x70

**Box:** da 100 pz.

 **BSTROFWH**  
bianco

 **BSTROF68**  
bianco con bande colorate



TESSUTO SPINATO

A young man with a beard and mustache, wearing a bright yellow hard hat and an orange safety vest over a black shirt, is smiling and looking towards the right. He is operating a piece of machinery in a factory or industrial setting. The background is filled with industrial equipment and structures, with a warm, golden light illuminating the scene. The text 'forniture antinfortunistiche' is overlaid in white on a semi-transparent orange band across the lower part of the image.

forniture  
antinfortunistiche



## Giubbino Alta Visibilità

**cod. AA2GIUAR** (arancio)

Giubbino con bottoni coperti, due tasche anteriori con pattina e bottone al petto, bottone ai polsi.

**CE** SECONDA CATEGORIA CLASSE 3

Norma di riferimento: UNI EN 20471: 2013

Norma di riferimento: UNI EN 13688: 2013

**Composizione tessuto:**

65% cotone - 35% poliestere  
con bande rinfrangenti

**Grammatura tessuto:** 210 gr/mq

**Taglie:** dalla M alla 3XL

(dalla 44 alla 64 **ad esaurimento**)

**Box:** da 18 pz. per taglia

## Pantalone Alta Visibilità

**cod. AA2PANAR** (arancio)

Pantalone lavoro con bottoni coperti, due tasche anteriori, tasca posteriore con bottone, portametro.

**CE** SECONDA CATEGORIA CLASSE 2

Norma di riferimento: UNI EN 20471: 2013

Norma di riferimento: UNI EN 13688: 2013

**Composizione tessuto:**

65% cotone - 35% poliestere  
con bande rinfrangenti

**Grammatura tessuto:** 210 gr/mq

**Taglie:** dalla S alla 3XL

(dalla 44 alla 64 **ad esaurimento**)

**Box:** da 18 pz. per taglia





## Salopette Alta Visibilità

**cod. AA2SALAR** (arancio)

Salopette lavoro con apertura laterale con bottoni, elastico in vita, tessuto salvareni, ganci in plastica, tasche anteriori, tascone con cerniera, tasca posteriore con bottone, portametro.

**CE SECONDA CATEGORIA CLASSE 2**

Norma di riferimento: UNI EN 20471: 2013

Norma di riferimento: UNI EN 13688: 2013

**Composizione tessuto:**

65% cotone - 35% poliestere con bande rinfrangenti

**Grammatura tessuto:** 210 gr/mq

**Taglie:** dalla M alla XXL

(dalla 44 alla 64 **ad esaurimento**)

**Box:** da 15 pz. per taglia



## Tuta Alta Visibilità

**cod. AA2TUTAR** (arancio)

Tuta lavoro con cerniera coperta, elastico posteriore in vita, due taschini con pattina e bottone al petto, due tasche anteriori, tasca posteriore con bottone, portametro.

**CE SECONDA CATEGORIA CLASSE 3**

Norma di riferimento: UNI EN 20471: 2013

Norma di riferimento: UNI EN 13688: 2013

**Composizione tessuto:**

65% cotone - 35% poliestere  
con bande rinfrangenti

**Grammatura tessuto:**

210 gr/mq

**Taglie:** dalla M alla 3XL

(dalla 44 alla 64 **ad esaurimento**)

**Box:** da 10 pz. per taglia



## Parka 5 usi Alta Visibilità

### cod. AAVPR5

Parka ad alta visibilità 5 usi, impermeabile, cappuccio a scomparsa. Interno staccabile con maniche staccabili, reversibile.

CE

giaccone esterno:

SECONDA CATEGORIA CLASSE 3

giacca interna (senza maniche):

SECONDA CATEGORIA CLASSE 2

Norma di riferimento: UNI EN 20471: 2013

Norma di riferimento: UNI EN 13688: 2013

Taglie: dalla M alla XXL

Box: da 10 pz. per taglia

 AAVPR5AB  
arancio/blu

 AAVPR5GB  
giallo/blu







## Parka Alta Visibilità

**cod. AAVPRK**

Parka fisso ad alta visibilità, impermeabile, cappuccio a scomparsa.

**CE SECONDA CATEGORIA CLASSE 3**

Norma di riferimento: UNI EN 20471: 2013

Norma di riferimento: UNI EN 13688: 2013

**Taglie:** dalla M alla XXL

**Box:** da 10 pz. per taglia



## Gilet Alta Visibilità

**cod. NGILAV**

Gilet ad alta visibilità.

**CE SECONDA CATEGORIA CLASSE 2**

Norma di riferimento: UNI EN 20471: 2013

Norma di riferimento: UNI EN 13688: 2013

**Composizione tessuto:**

100% poliestere con bande rinfrangenti

**Taglie:** unica

**Box:** da 50/100 pz. per taglia



**NELMPOGI**  
giallo

**NELMPOBI**  
bianco

**NELMPOAR**  
arancio



**NELMPOBL**  
blu



**NELMPORO**  
rosso

**NELMPOVE**  
verde

## Elmetto in polietilene

**cod. NELMPO**

Elmetto in polietilene omologato CE EN 397 con fori per sottogola, calotta interna fornita smontata.

**Taglie:** unica

**Box:** da 60 pz.



## Stivale antinfortunistico

**cod. NSTIAN**

Stivale antinfortunistico con puntale e lamina in acciaio.

**CE S5 - SRC**

Norma di riferimento: EN ISO 20345:2011 SRC

**Taglie:** dalla 37 alla 47    **Box:** da 5 paia per taglia



NSTIANVE  
verde



NSTIANGI  
giallo



NSTIANVE  
verde

## Stivale nitrile bianco

**cod. NSTINIBI** (bianco)

Stivale in pvc nitrilico bianco.

**CE** Norma di riferimento:

EN ISO 20347:2012 SRA

**Taglie:** dalla 38 alla 46

**Box:** da 8 paia per taglia

**ad esaurimento scorte**



Innovazione al servizio della **sicurezza** e del **benessere**

**Ammortizzazione: l'intersuola infnergy®** trattiene e restituisce l'energia accumulata ad ogni passo.



**DISPONIBILI  
ALTRI MODELLI  
SU ORDINAZIONE**

## Point cod. NRL20036

### Tomaia:

Nylon ultra traspirante e morbida pelle scamosciata, soffetto nylon imbottito

**Taglie:** dalla 38 alla 48

**Box:** da 10 paia per taglia



Fodera a tunnel d'aria che garantisce elevata traspirabilità



Puntale forato con membrana resistente a 200J



Intersuola antiperforazione non metallica, 100% della superficie protetta



Intersuola composta da migliaia di capsule che trattengono e restituiscono l'energia accumulata ad ogni tuo passo abbinata ad un inserto in gel defaticante. Suola in PU/PU per un comfort ottimale e con eccezionale coefficiente di resistenza allo scivolamento. Tacco preformato di altezza 6 mm polifunzionale.

### RESISTENZA ALLO SCIVOLAMENTO

		VALORI MINIMI	Red Lion
SRC (SRA+SRB)	SRA	Pianta	0,32 <b>0,82</b>
	Tacco	0,28 <b>0,60</b>	
SRB	Pianta	0,18 <b>0,30</b>	
	Tacco	0,13 <b>0,18</b>	

REQUISITI DI RESISTENZA ALLO SCIVOLAMENTO SECONDO LA EN ISO 20345:2011 CON METODO SECONDO LA EN 13287:2002



Soletta anatomica in PU antibatterico e traspirante con canali per circolazione d'aria



rapido sfilamento

**BEST PRICE**

Safe  
NUE10013

S3 RS SRC CE

Simple  
NUE20013

S3 SRC CE



**Safe** cod. NUE10013

**Simple** cod. NUE20013

\*VERSIONE ALTA CON RAPIDO SFILAMENTO\*

**Tomaia:** Pelle stampata, idrorepellente

**Puntale:** Acciaio

**Antiperforazione:** Lamina acciaio ergonomica

**Taglie:** dalla 35 alla 48

**Box:** da 10 paia per taglia



Rotational  
NBN20035

S1P SRC CE

**Movida** cod. NUE20025

**Tomaia:** Pelle scamosciata forata

**Puntale:** Acciaio

**Antiperforazione:** Lamina acciaio ergonomica

**Taglie:** dalla 35 alla 48

**Box:** da 10 paia per taglia

Movida  
NUE20025

S1P SRC CE



**BEST PRICE**

**Rotational** cod. NBN20035

**Tomaia:** Pelle scamosciata grigia forata

**Puntale:** Acciaio

**Antiperforazione:** Lamina acciaio ergonomica

**Taglie:** dalla 35 alla 48

**Box:** da 10 paia per taglia

**Anaconda** cod. NBN10025

**Soffietto** cod. NBN20025

\*VERSIONE ALTA CON RAPIDO SFILAMENTO\*

**Tomaia:** Pelle stampata

**Puntale:** Acciaio

**Antiperforazione:** Lamina acciaio ergonomica

**Taglie:** dalla 35 alla 48

**Box:** da 10 paia per taglia

Soffietto  
NBN20025

S1P SRC CE

rapido sfilamento

Anaconda  
NBN10025

S1P RS SRC CE

